

GENERALITÀ / FEATURES

Elettropompe centrifughe, monoblocco e monogirante, con corpo pompa, realizzato in accordo alle norme EN 733, collegato al motore mediante supporto, adatte per il pompaggio di acqua pulita e di altri liquidi chimicamente e meccanicamente non aggressivi. La possibilità di installazione in qualunque posizione, fatta eccezione di quella che comporta la bocca aspirante rivolta verso l'alto, unitamente alla forma costruttiva rende agevole e conveniente l'utilizzo per le più svariate esigenze in campo civile, agricolo, industriale o impiantistico in generale. Standard vengono fornite di controflangia.

Centrifugal, single impeller electric pumps with pump body built according to EN 733 Standards, connected to the motor through a support unit, suitable for pumping clean water and chemically and mechanically non aggressive liquids. It can be installed in any position excluding the one with inlet up-wards and this, along with its special design, makes it use easier and more convenient in most fields: civil, industrial, agricultural. Standards supply with counter-flange.

MATERIALI / MATERIALS

- Corpo pompa e supporto motore in ghisa
- Girante in ghisa (su richiesta in bronzo o acciaio)
- Albero in acciaio inossidabile AISI 304
- Tenuta meccanica in ceramica-grafite
- *Cast-iron pump body and motor bracket*
- *Cast-iron impeller (bronze or stainless steel impeller upon request)*
- *Stainless steel shaft AISI 304*
- *Ceramic graphite mechanical seal*

MOTORE / MOTOR

- Motore ad induzione
- Grado di protezione IP55
- Isolamento classe F
- Alimentazione monofase 230V-50Hz
- Alimentazione trifase 230/400V-50Hz fino a 5,5 Hp, 400/690V-50Hz per potenze superiori a 7,5 Hp
- *Closed induction motor*
- *Protection degree: IP55*
- *Insulation class: F*
- *Single-phase feeding 230V-50Hz*
- *Three-phase feeding 230/400V-50Hz up to 5,5 Hp, 400/690V-50Hz for rated output from 7,5 Hp*

LIMITI DI IMPIEGO / OPERATING CONDITIONS

- Pressione max: 10 bar
- Temperatura del liquido: -10 +90°C
- *Max. operating pressure: 10 bar*
- *Liquid temperature: -10 +90°C*

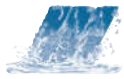

MODELLO POMPA PUMP'S MODEL	P2 nom.		I	Q (m³/h - l/min)																
				0	4,5	6	7,5	9	12	15	18	21	24	27	30	33	36	39	42	
	(HP)	(kW)	3x400V 50 Hz	0	75	100	125	150	200	250	300	350	400	450	500	550	600	650	700	
			H (m)																	
CM 32-160C (1~)	2	1,5	4	24,7	24,4	24,1	23,6	23	21,5	19,6	17,2	14,1								
CM 32-160B (1~)	3	2,2	5,2	29		28,5	28	27,3	25,7	23,8	21,4	18,5	14,8							
CM 32-160A	4	3	7,1	36,8		36,4	36	35,4	34,2	32,8	31,1	28,8	26	22,3						
CM 32-200C (1~)	5,5	4,0	8,8	40,1		39,7	39,6	39,3	38,3	36,9	35,2	33,0	30,4	27,6						
CM 32-200B1	7,5	5,5	11,1	46,4		46,5	46,4	46,2	45,4	44,2	42,5	40,5	38,3	35,7	32,5					
CM 32-200B	7,5	5,5	12,4	50,1		50,2	50,1	49,9	49,3	48,0	46,4	44,5	42,4	39,8	37,2					
CM 32-200A1	10	7,5	13,1	55,1		55,1	55,0	54,9	54,2	52,9	51,2	49,2	46,8	44,3	41,6					
CM 32-200A	10	7,5	15,0	58,6		59,0	58,9	58,8	58,2	57,1	55,5	53,4	51,1	48,4	45,6	42,5				
CM 32-250C	12,5	9,2	20,1	70			68,5	68,0	67,0	65,5	63,5	61	58	50	36,5					
CM 32-250B	15	11	24,2	82			81,0	80,5	79,5	78,5	77,0	74,5	71,9	65	52,5					
CM 32-250A1	20	15	27,4	91,0			90,0	89,9	89,0	88,0	86,0	83,5	80,8	74	61,5					
CM 32-250A	20	15	30,1	93,0			92,5	92,0	91,5	90,5	89,5	87,5	85	78,5	66					
CM 40-125C (1~)	2	1,5	3,6	18,9				19	18,8	18,3	17,7	16,9	15,9	14,7	13,2	11,6	9,9			
CM 40-125B (1~)	3	2,2	4,8	22,5				22,9	22,8	22,5	21,9	21,2	20,3	19,2	18,0	16,7	15,2	13,4		
CM 40-125A	4	3	6,4	26,2				26,6	26,5	26,3	25,9	25,2	24,4	23,4	22,2	20,9	19,4	17,8	16,0	
CM 40-160B (1~)	4	3,0	7,2	30,0				30,1	30,0	29,6	29,0	28,2	27,1	25,9	24,4	22,8	21,0	19,1		
CM 40-160A (1~)	5,5	4,0	9,2	35,4				35,6	35,5	35,3	35,0	34,2	33,2	32,0	30,6	29,0	27,3	25,4	23,5	
CM 40-200B1	7,5	5,5	11,1	42,2				42,4	42,3	42,1	41,3	40,3	39,1	37,5	35,5	33,3	30,7	28,0		
CM 40-200B	7,5	5,5	12,7	44,7				44,9	44,8	44,6	44,0	42,9	41,6	40,0	38,1	36,1	33,6	30,8	27,9	
CM 40-200A1	10	7,5	13,8	49,7				49,7	49,7	49,4	48,7	47,9	46,6	45,0	43,2	41,1	38,6	35,9		
CM 40-200A	10	7,5	16,5	57,7				57,7	57,5	57,1	56,3	55,4	54,1	52,5	50,5	48,5	45,9	43,3	40,3	
CM 40-250C	12,5	9,2	20,2	63,0				62,6	62,4	61,9	61,3	60,5	59,7	58,6	57,1	55,0	52,4	49,6		
CM 40-250B	15	11	23,9	70,8				71,3	71,2	71,0	70,5	69,8	68,4	66,6	65,4	63,8	61,2	58,5	55,6	
CM 40-250A1	20	15	26,9	77,9				78,5	78,4	78,2	77,8	77,3	76,6	75,5	74,1	72,5	70,2	67,4	64,3	
CM 40-250A	20	15	31,3	86,1				86,3	86,5	86,4	86,0	85,6	85,0	84,1	82,9	81,3	79,4	77,0	74,3	
CM 40-250BM	25	18,5	38	93,1				93,8	94,2	94,2	93,8	93,4	92,9	92,2	91,3	90,2	88,8	87,3	85,6	
CM 40-250AM	30	22	43	101,6				101,9	101,6	101,4	101,2	101,0	100,7	100,3	99,7	98,9	97,8	96,3	94,6	
CM 50-125B (1~)	4	3	7,1	19,8					20,2	20,2	20,1	20,0	19,8	19,5	19,3	18,8	18,5	18,0	17,6	
CM 50-125A (1~)	5,5	4	9,6	24,8					25,2	25,2	25,1	25,0	24,8	24,6	24,3	23,9	23,5	23,2	22,7	
CM 50-160B1	7,5	5,5	10,7	29,3									30,3	30,2	30,0	29,6	29,0	28,4	27,7	26,9
CM 50-160B	7,5	5,5	11,6	31,1									32,1	32,0	31,7	31,4	31,0	30,4	29,7	28,9
CM 50-160A1	10	7,5	14,1	34,3									35,4	35,3	35,0	34,7	34,3	33,8	33,2	32,4
CM 50-160A	10	7,5	15,8	36,7									37,9	37,8	37,7	37,4	37,1	36,6	36,1	35,4
CM 50-200C	12,5	9,2	18,5	46,0										45,6	45,1	44,5	43,7	42,9	41,8	40,8
CM 50-200B	15	11	21	50,8										51,0	50,5	50,0	49,3	48,5	47,7	46,8
CM 50-200A1	20	15	25,4	57,0										57,3	57,1	56,7	56,2	55,6	54,8	54,1
CM 50-200A	20	15	27	58,0										58,3	58,0	57,5	57,0	56,4	55,7	55,0
CM 50-250C	20	15	32,5	71,5											70,8	70,3	69,7	69,0	68,3	67,6
CM 50-250B	25	18,5	41,5	78,0											78,0	77,4	76,8	76,1	75,3	74,5
CM 50-250A	30	22	51,5	90,0											89,5	88,8	88,3	87,7	86,9	86,1
CM 65-125B1	7,5	5,5	11	19,4												20,4	20,4	20,3	20,2	20,1
CM 65-125B	7,5	5,5	12,6	20,9												22,0	22,0	21,9	21,8	21,7
CM 65-125A1	10	7,5	14	23												24,1	24,1	24,0	23,9	23,8
CM 65-125A	10	7,5	16,3	25,4												26,4	26,4	26,4	26,3	26,3
CM 65-160C	12,5	9,2	19,5	29,8																31,2
CM 65-160B	15	11,0	22,5	33,0																34,6
CM 65-160A1	20	15	27,6	37,1																38,5
CM 65-160A	20	15,0	30,0	39,2																40,6
CM 65-200C1	20	15	28,8	43,1																
CM 65-200C	20	15	31,4	45,3																
CM 65-200B	25	18,5	38,2	51,6																
CM 65-200A	30	22	43,8	60,2																
CM 65-250B	40	30	63,5	81,0																
CM 65-250A	50	37	74,5	90,0																
CM 80-160E	12,5	9,2	17,2	21,4																
CM 80-160D	15	11	22,1	25,4																
CM 80-160C1	20	15	25,5	28,5																
CM 80-160C	20	15	27,4	29,7																
CM 80-160B	25	18,5	34,8	34																
CM 80-160A	30	22	39,8	38,8																
CM 80-200B	40	30	63,5	49,0																
CM 80-200A	50	37	74,5	58,0																
CM 100-160B	40	30	57,2	41,8																
CM 100-160A	50	37	65	45,7																

(1~) Disponibile in versione monofase - *Single phase available*

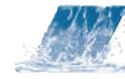

ELETTROPOMPE CENTRIFUGHE NORMALIZZATE
CLOSE COUPLED CENTRIFUGAL ELECTRIC PUMPS

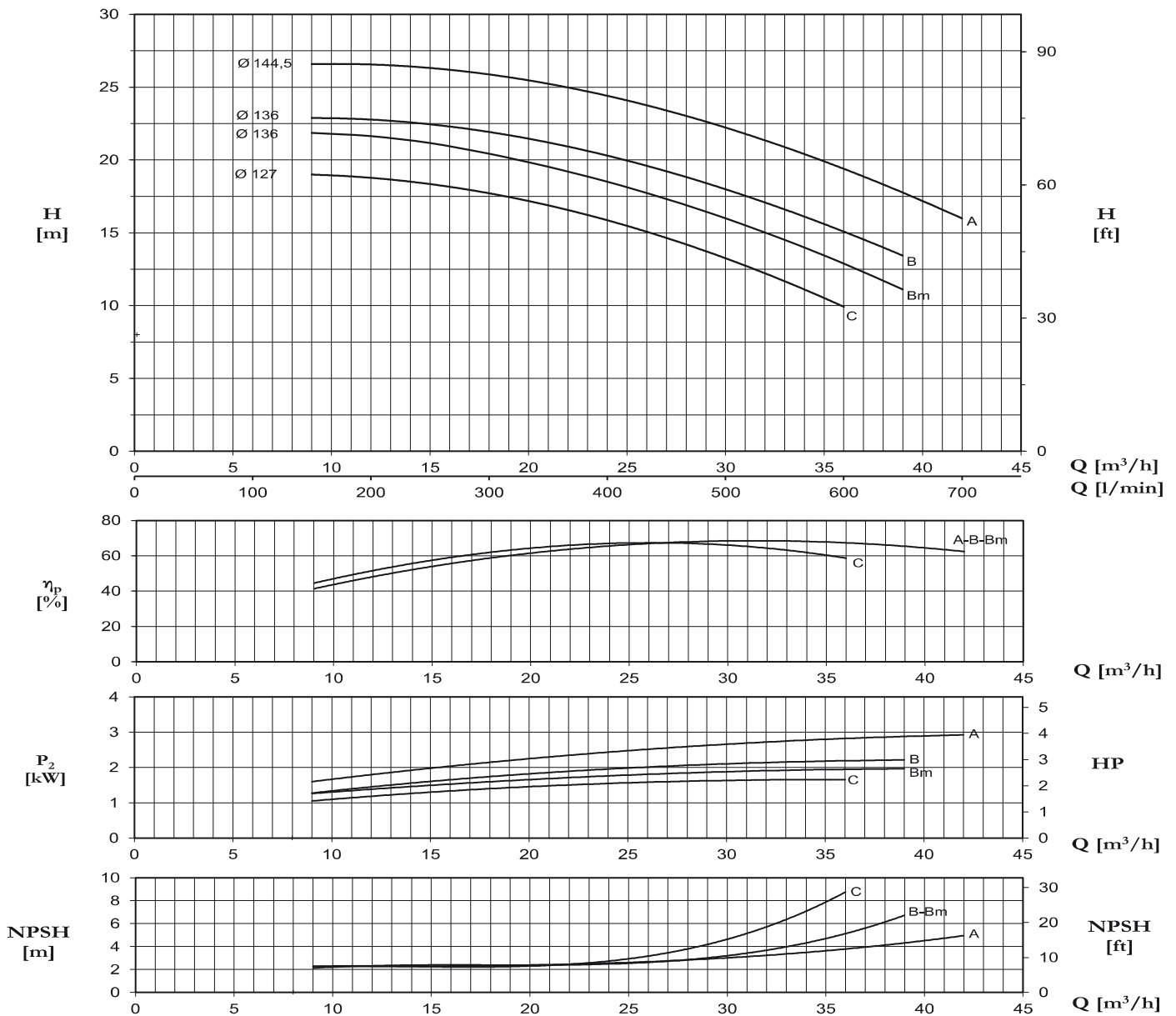

Tolerance: ISO 9906:2012 - Grade 3B

CARATTERISTICHE TECNICHE A 2900 GIRI / TECHNICAL PERFORMANCE AT 2900 RPM

Modello - Model		P2		A		Q (m³/h - l/min)									
1~	3~			1~	3~	0	9	15	21	27	30	33	36	39	42
		(HP)	(kW)	1x230 V 50 Hz	3x400 V 50 Hz	H (m)									
CM 40-125 CM	CM 40-125 C	2	1,5	10	3,6	18,9	19	18,3	16,9	14,7	13,2	11,6	9,9	-	-
	CM 40-125 B	3	2,2	-	4,8	22,5	22,9	22,5	21,2	19,2	18	16,7	15,2	13,4	-
CM 40-125 BM		3	2,2	12,2	-	21,9	21,9	21,2	19,5	17,3	16	14,5	12,9	11,1	-
	CM 40-125 A	4	3	-	6,4	26,2	26,6	26,3	25,2	23,4	22,2	20,9	19,4	17,8	16

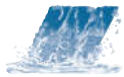

SERIE - SERIES

CM

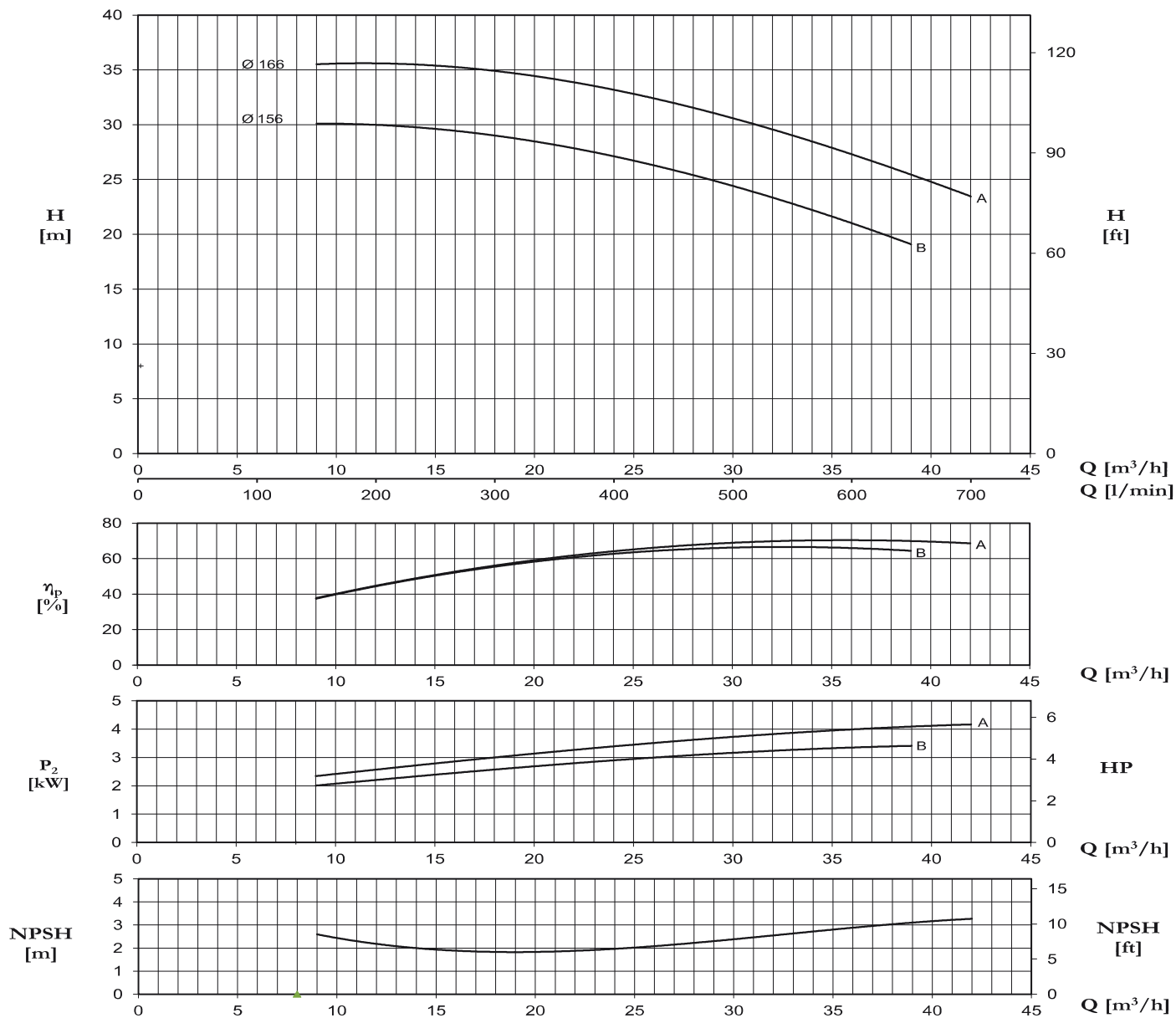

Tolerance: ISO 9906:2012 - Grade 3B

CARATTERISTICHE TECNICHE A 2900 GIRI / TECHNICAL PERFORMANCE AT 2900 RPM

Modello - Model		P2		A		Q (m³/h - l/min)													
1~	3~			1~	3~	0	9	12	15	18	21	24	27	30	33	36	39	42	
						0	150	200	250	300	350	400	450	500	550	600	650	700	
		(HP)	(kW)	1x230 V 50 Hz	3x400 V 50 Hz	H (m)													
CM 40-160 B	CM 40-160 B	4	3	19,0	7,2	30,0	30,1	30,0	29,6	29,0	28,2	27,1	25,9	24,4	22,8	21,0	19,1	-	
CM 40-160 A	CM 40-160 A	5,5	4	24,5	9,2	35,4	35,6	35,5	35,3	35,0	34,2	33,2	32,0	30,6	29,0	27,3	25,4	23,5	

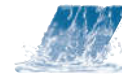

ELETTROPOMPE CENTRIFUGHE NORMALIZZATE
CLOSE COUPLED CENTRIFUGAL ELECTRIC PUMPS

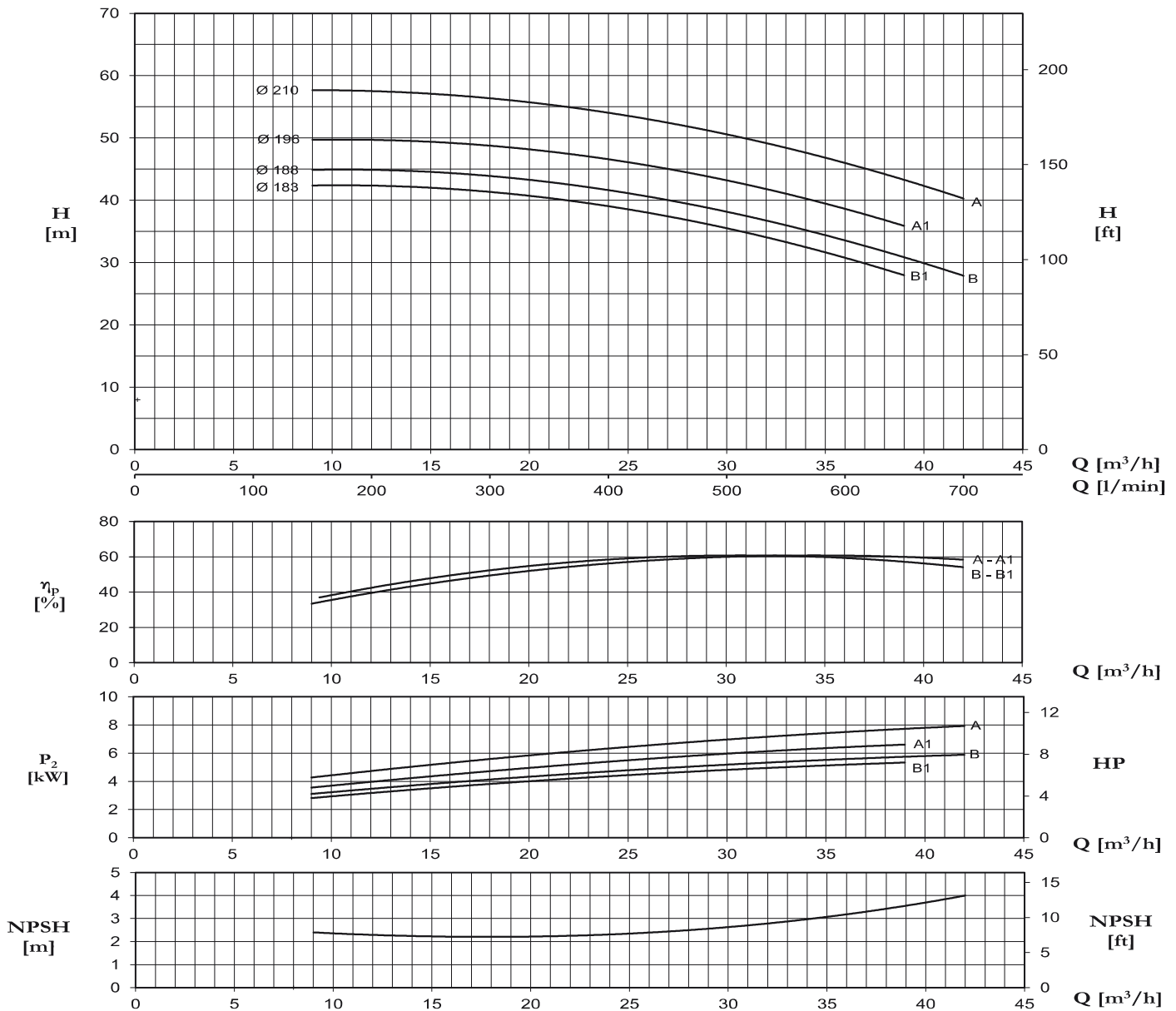

Tolerance: ISO 9906:2012 - Grade 3B

CARATTERISTICHE TECNICHE A 2900 GIRI / TECHNICAL PERFORMANCE AT 2900 RPM

Modello - Model	P2		A	Q (m³/h - l/min)													
				0	9	12	15	18	21	24	27	30	33	36	39	42	
3~	(HP)	(kW)	3~ 3x400V 50 Hz	H (m)													
				0	150	200	250	300	350	400	450	500	550	600	650	700	
CM 40-200 B1	7,5	5,5	11,1	42,2	42,4	42,3	42,1	41,3	40,3	39,1	37,5	35,5	33,3	30,7	28,0	-	
CM 40-200 B	7,5	5,5	12,7	44,7	44,9	44,8	44,6	44,0	42,9	41,6	40,0	38,1	36,1	33,6	30,8	27,9	
CM 40-200 A1	10	7,5	13,8	49,7	49,7	49,7	49,4	48,7	47,9	46,6	45,0	43,2	41,1	38,6	35,9	-	
CM 40-200 A	10	7,5	16,5	57,7	57,7	57,5	57,1	56,3	55,4	54,1	52,5	50,5	48,5	45,9	43,3	40,3	

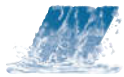

SERIE - SERIES

CM

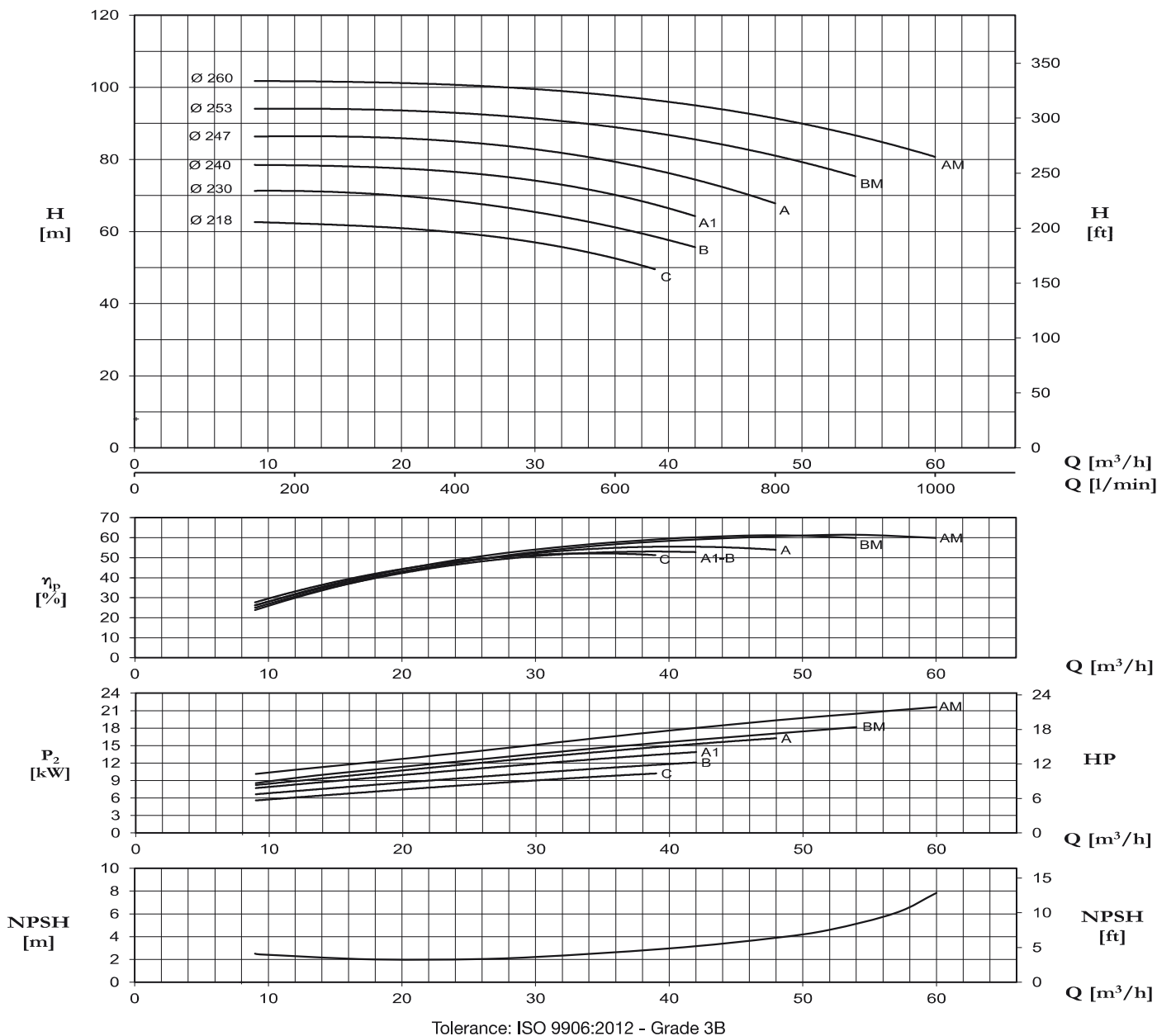

CARATTERISTICHE TECNICHE A 2900 GIRI / TECHNICAL PERFORMANCE AT 2900 RPM

Modello - Model	P2		A	Q (m³/h - l/min)									
				0	9	18	24	30	39	42	48	54	60
3~			3~	0	150	300	400	500	650	700	800	900	1000
	(HP)	(kW)	3x400 V 50 Hz	H (m)									
CM 40-250 C	12,5	9,2	20,2	63,0	62,6	61,3	59,7	57,1	49,6	-	-	-	-
CM 40-250 B	15	11	23,9	70,8	71,3	70,5	68,4	65,4	58,5	55,6	-	-	-
CM 40-250 A1	20	15	26,9	77,9	78,5	77,8	76,6	74,1	67,4	64,3	-	-	-
CM 40-250 A	20	15	31,3	86,1	86,3	86,0	85,0	82,9	77,0	74,3	67,9	-	-
CM 40-250BM (4)	25	18,5	38	93,1	93,8	93,8	92,9	91,3	87,3	85,6	81,4	75,1	-
CM 40-250AM (4)	30	22	43	101,6	101,9	101,2	100,7	99,7	96,3	94,6	91,2	87,0	80,6

(4) : max 14 bar

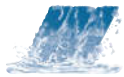

CM

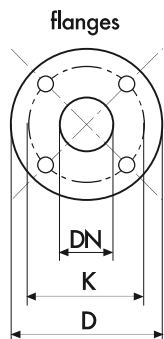
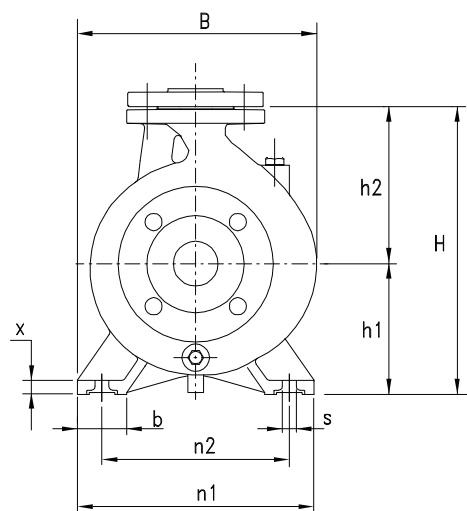
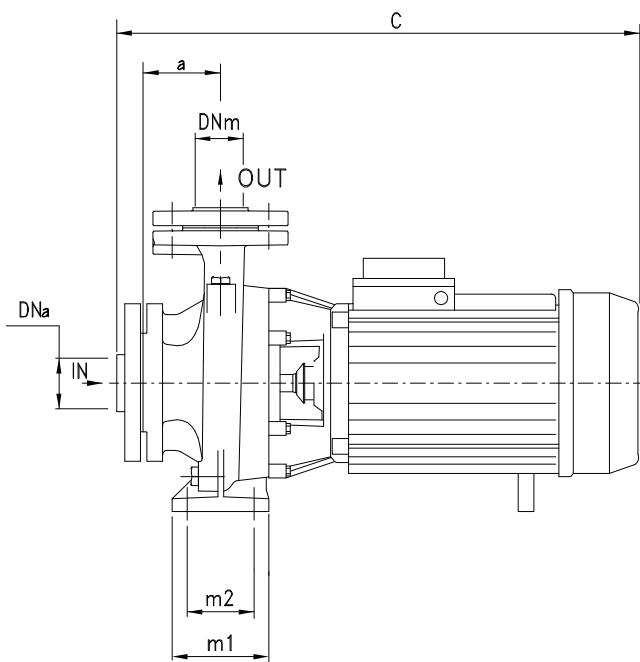

DIMENSIONI mm DIMENSIONS mm				
DN	D	K	FORI / HOLES	
			n°	Ø
32	140	100	4	18
40	150	110	4	18
50	165	125	4	18
65	185	145	4	18
80	200	160	4	18
100	220	180	8	18
125	250	210	8	18

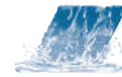

MODELLO POMPA PUMP'S MODEL	DIMENSIONI POMPA mm PUMP'S DIMENSIONS mm																		PESO WEIGHT
	DNa	DNm	a	h1	h2	m1	m2	n1	n2	b	x	s	C	B	H	I	L	M	
CM 32-160 C	50	32	80	132	160	100	70	240	190	50	12	14	490	240	292	520	260	355	38
CM 32-160 B	50	32	80	132	160	100	70	240	190	50	12	14	490	240	292	520	260	355	39
CM 32-160 A	50	32	80	132	160	100	70	240	190	50	12	14	490	240	292	520	260	355	42
CM 32-200 C	50	32	80	160	180	100	70	240	190	50	12	14	505	268	340	530	305	400	51,5
CM 32-200 B1	50	32	80	160	180	100	70	240	190	50	12	14	520	268	340	615	310	460	61
CM 32-200 B	50	32	80	160	180	100	70	240	190	50	12	14	565	268	340	615	310	460	63
CM 32-200 A1	50	32	80	160	180	100	70	240	190	50	12	14	520	268	340	615	310	460	67
CM 32-200 A	50	32	80	160	180	100	70	240	190	50	12	14	565	268	340	615	310	460	69
CM 32-250 C	50	32	100	180	225	125	95	320	250	65	12	14	625	305	405	665	335	535	83
CM 32-250 B	50	32	100	180	225	125	95	320	250	65	14	14	625	305	405	665	335	535	90
CM 32-250 A1	50	32	100	180	225	125	95	320	250	65	14	14	625	305	405	665	335	535	95
CM 32-250 A	50	32	100	180	225	125	95	320	250	65	14	14	695	305	405	735	355	535	120
CM 40-125 C	65	40	80	112	140	100	70	210	160	50	12	14	495	220	252	520	260	355	36
CM 40-125 B	65	40	80	112	140	100	70	210	160	50	12	14	495	220	252	520	260	355	37
CM 40-125 A	65	40	80	112	140	100	70	210	160	50	12	14	495	220	252	520	260	355	40
CM 40-160 B	65	40	80	132	160	100	70	240	190	50	12	14	500	245	292	520	260	355	47
CM 40-160 A	65	40	80	132	160	100	70	240	190	50	15	14	500	245	292	520	260	355	50
CM 40-200 B1	65	40	100	160	180	100	70	240	190	50	15	14	545	273	340	615	310	460	63
CM 40-200 B	65	40	100	160	180	100	70	265	212	50	15	14	590	273	340	615	310	460	65
CM 40-200 A1	65	40	100	160	180	100	70	240	190	50	15	14	545	273	340	615	310	460	69
CM 40-200 A	65	40	100	160	180	100	70	265	212	50	15	14	590	273	340	615	310	460	71
CM 40-250 C	65	40	100	180	225	125	95	320	250	65	15	14	630	322	405	665	335	535	84
CM 40-250 B	65	40	100	180	225	125	95	320	250	65	15	14	630	322	405	665	335	535	91
CM 40-250 A1	65	40	100	180	225	125	95	320	250	65	15	14	630	322	405	665	335	535	96
CM 40-250 A	65	40	100	180	225	125	95	320	250	65	15	14	700	322	405	735	355	535	121
CM 40-250 BM	65	50	100	180	225	125	95	320	250	65	14	14	750	332	405	815	355	535	140
CM 40-250 AM	65	50	100	180	225	125	95	320	250	65	14	14	750	332	405	815	355	535	149
CM 50-125 B	65	50	100	132	160	100	70	240	190	50	12	14	525	250	292	520	260	355	47
CM 50-125 A	65	50	100	132	160	100	70	240	190	50	12	14	525	250	292	520	260	355	50
CM 50-160 B1	65	50	100	160	180	100	70	265	212	50	12	14	545	270	340	615	310	460	63
CM 50-160 B	65	50	100	160	180	100	70	265	212	50	12	14	590	270	340	615	310	460	65
CM 50-160 A1	65	50	100	160	180	100	70	265	212	50	12	14	545	270	340	615	310	460	69
CM 50-160 A	65	50	100	160	180	100	70	265	212	50	12	14	590	270	340	615	310	460	71
CM 50-200 C	65	50	100	160	200	100	70	265	212	50	12	14	635	290	360	665	335	535	82
CM 50-200 B	65	50	100	160	200	100	70	265	212	50	12	14	635	290	360	665	335	535	89
CM 50-200 A1	65	50	100	160	200	100	70	265	212	50	12	14	635	290	360	665	335	535	94
CM 50-200 A	65	50	100	160	200	100	70	265	212	50	12	14	705	290	360	735	355	535	122
CM 50-250 C	65	50	100	180	225	125	95	320	250	65	14	14	705	332	405	735	355	535	125
CM 50-250 B	65	50	100	180	225	125	95	320	250	65	14	14	750	332	405	815	355	535	140
CM 50-250 A	65	50	100	180	225	125	95	320	250	65	14	14	750	332	405	815	355	535	149
CM 65-125 B1	80	65	100	160	180	125	95	280	212	65	14	14	560	280	340	615	310	460	62
CM 65-125 B	80	65	100	160	180	125	95	280	212	65	14	14	605	280	340	615	310	460	64
CM 65-125 A1	80	65	100	160	180	125	95	280	212	65	14	14	560	280	340	615	310	460	68
CM 65-125 A	80	65	100	160	180	125	95	280	212	65	14	14	605	280	340	615	310	460	70
CM 65-160 C	80	65	100	160	200	125	95	280	212	65	14	14	635	290	360	665	335	535	84
CM 65-160 B	80	65	100	160	200	125	95	280	212	65	14	14	635	290	360	665	335	535	90
CM 65-160 A1	80	65	100	160	200	125	95	280	212	65	14	14	635	290	360	665	355	535	95
CM 65-160 A	80	65	100	160	200	125	95	280	212	65	14	14	705	290	360	735	355	535	120
CM 65-200 C1	80	65	100	180	225	125	95	320	250	65	14	14	675	330	405	735	355	535	92
CM 65-200 C	80	65	100	180	225	125	95	320	250	65	14	14	705	330	405	735	355	535	122
CM 65-200 B	80	65	100	180	225	125	95	320	250	65	14	14	750	330	405	815	355	535	138
CM 65-200 A	80	65	100	180	225	125	95	320	250	65	14	14	750	330	405	815	355	535	148
CM 65-250 B	80	65	100	200	250	160	120	360	280	80	16	19	820	370	450	850	380	490	194
CM 65-250 A	80	65	100	200	250	160	120	360	280	80	16	19	820	370	450	850	380	490	214
CM 80-160 E	100	80	125	180	225	125	95	320	250	65	14	14	665	330	405	665	335	535	92
CM 80-160 D	100	80	125	180	225	125	95	320	250	65	14	14	665	330	405	665	335	535	98,5
CM 80-160 C1	100	80	125	180	225	125	95	320	250	65	14	14	665	330	405	665	335	535	104
CM 80-160 C	100	80	125	180	225	125	95	320	250	65	14	14	735	330	405	735	355	535	129
CM 80-160 B	100	80	125	180	225	125	95	320	250	65	14	14	780	330	405	815	355	535	143
CM 80-160 A	100	80	125	180	225	125	95	320	250	65	14	14	780	330	405	815	355	535	152
CM 80-200 B	100	80	125	180	250	125	95	345	280	65	16	14	840	355	405	850	380	490	189
CM 80-200 A	100	80	125	180	250	125	95	345	280	65	16	14	840	355	405	850	380	490	209
CM 100-160 B	125	100	125	200	280	160	120	360	280	80	18	18	842	390	480	850	420	570	198
CM 100-160 A	125	100	125	200	280	160	120	360	280	80	18	18	842	390	480	850	420	570	230