

Monobloc horizontal centrifugal pumps, constructed in compliance with EN 733 standards; widely used in water supplies, pressurisation and fire-fighting systems, cooling, heating, irrigation, industrial and agricultural applications; standard supply with counter-flange.

### Construction features

<b>Pump body</b>	cast iron
<b>Motor bracket</b>	cast iron
<b>Impeller</b>	cast iron, bronze or stainless steel
<b>Mechanical seal</b>	ceramic-graphite-NBR
<b>Pump shaft end</b>	stainless steel AISI 304
<b>Liquid temperature</b>	-10 ÷ +90 °C
<b>Operating pressure</b>	max 10 bar

### Motor

<b>2 Poles induction motor</b>	3~ 230/400V - 50Hz P ≤ 4kW
	3~ 400/690V - 50Hz P > 4kW
	1~ 230V-50Hz
<b>Insulation class</b>	F
<b>Protection degree</b>	IPX5

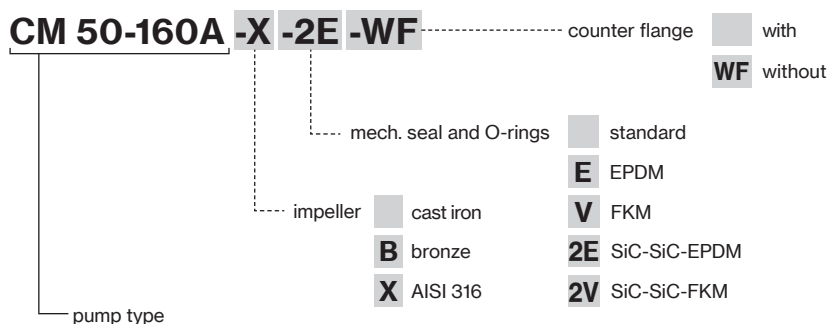

# CM-CMG-CA-4CA

Centrifugal Flanged  
EN 733

## 2 Poles

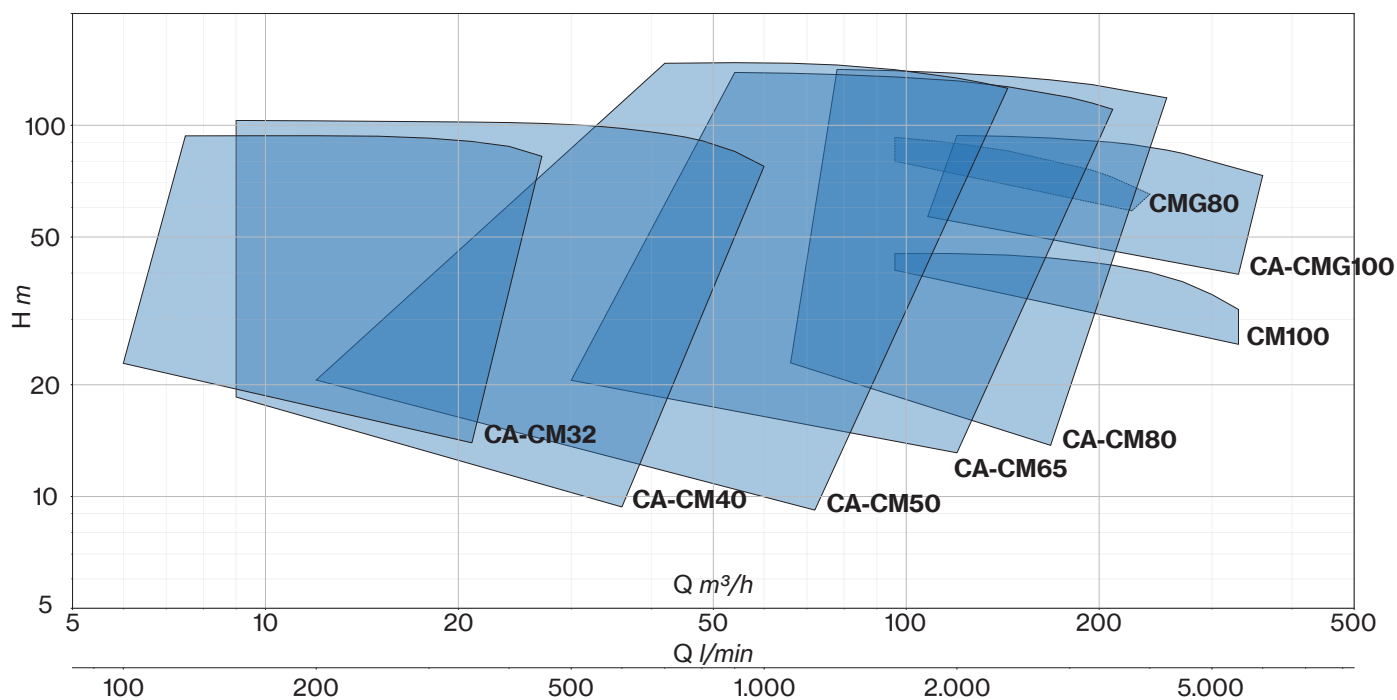

## 4 Poles

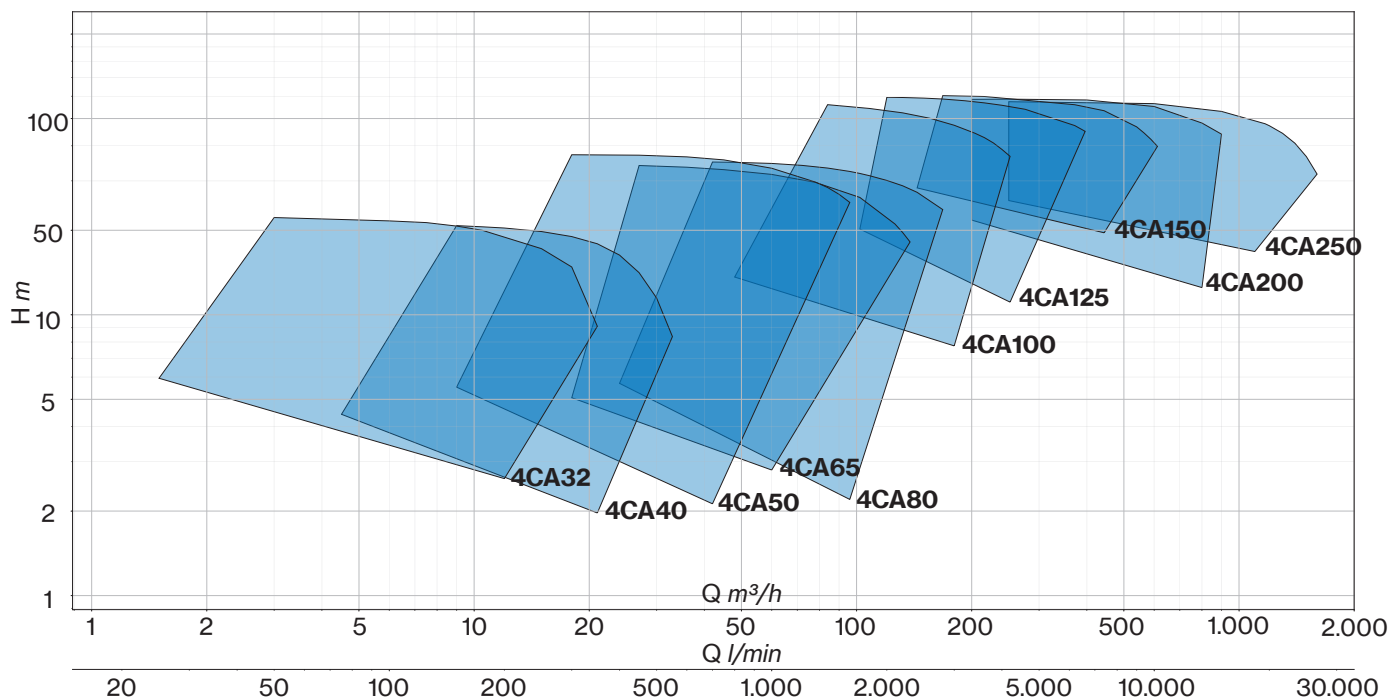

# CM-CMG-CA-4CA

Centrifugal Flanged  
EN 733

**CM:** Front suction close-coupled centrifugal pumps with close impeller mounted on IE3 motor shaft extension. Pump casing with axial suction and radial delivery on top, main dimensions and performance according to EN 733.

**CMG-CMGX:** Front suction centrifugal pumps connected to IE3 standard motor (stub-shaft construction). Pump casing with axial suction and radial delivery on top, main dimensions and performance according to EN 733.

**CA-CAX-4CA-4CAX:** Single-stage end-suction centrifugal frame-mounted pumps. Dimensions in accordance with EN 733.

TYPE	2 POLES					4 POLES					
	CM	CMG	CMGX	CA	CAT CAX CATX	Flow rate	Head	4CA 4CAT	4CAX 4CATX	Flow rate	Head
						m <sup>3</sup> /h	m			m <sup>3</sup> /h	m
32-160C	■	-	-	■	■	6 ÷ 21	22,8 ÷ 14	■	■	1,5 ÷ 12	5,9 ÷ 2,6
32-160B	■	-	-	■	■	6 ÷ 24	27,7 ÷ 17	■	■	1,5 ÷ 12	7,2 ÷ 3,6
32-160A	■	-	-	■	■	6 ÷ 27	36,2 ÷ 22,1	■	■	1,5 ÷ 15	8,8 ÷ 4
32-200C	■	-	-	■	■	6 ÷ 27	40,3 ÷ 28,7	■	■	3 ÷ 18	10,8 ÷ 4,2
32-200B1	■	-	-	-	-	6 ÷ 27	48 ÷ 37,9	-	-	-	-
32-200B	■	-	-	■	■	6 ÷ 30	48 ÷ 35,4	■	■	3 ÷ 18	12,7 ÷ 6,3
32-200A1	■	-	-	-	-	6 ÷ 30	58,3 ÷ 46,6	-	-	-	-
32-200A	■	-	-	■	■	6 ÷ 33	58,3 ÷ 44,3	■	■	3 ÷ 21	15,7 ÷ 6,8
32-250C	■	-	-	■	■	6 ÷ 27	72 ÷ 61,3	■	■	3 ÷ 21	17,2 ÷ 6,5
32-250B	■	-	-	■	■	7,5 ÷ 27	84 ÷ 73,2	■	■	3 ÷ 21	20 ÷ 8,3
32-250A1	■	-	-	-	-	7,5 ÷ 27	93,6 ÷ 85,3	-	-	-	-
32-250A	■	-	-	■	■	7,5 ÷ 27	93,6 ÷ 85,5	■	■	3 ÷ 21	22,2 ÷ 9,1
40-125C	■	-	-	■	■	9 ÷ 36	18,5 ÷ 9,4	■	■	4,5 ÷ 21	4,4 ÷ 2
40-125B	■	-	-	■	■	9 ÷ 39	23,4 ÷ 13,2	■	■	4,5 ÷ 21	5,5 ÷ 3,3
40-125A	■	-	-	■	■	9 ÷ 42	27,6 ÷ 16,8	■	■	4,5 ÷ 24	6,3 ÷ 3,4
40-160B	■	-	-	■	■	9 ÷ 36	29,2 ÷ 20,5	■	■	4,5 ÷ 24	7,5 ÷ 2,5
40-160A	■	-	-	■	■	9 ÷ 42	34,9 ÷ 23,4	■	■	4,5 ÷ 24	8,9 ÷ 4,5
40-160AP	■	-	-	■	■	9 ÷ 48	39,8 ÷ 25,3	■	■	4,5 ÷ 24	11,1 ÷ 6,8
40-200B1	■	-	-	-	-	9 ÷ 39	45,5 ÷ 32,3	-	-	-	-
40-200B	■	-	-	■	■	9 ÷ 42	45,5 ÷ 29,4	■	■	6 ÷ 24	11,4 ÷ 4,7
40-200A1	■	-	-	-	-	9 ÷ 39	56,5 ÷ 44,4	-	-	-	-
40-200A	■	-	-	■	■	9 ÷ 42	56,5 ÷ 41,6	■	■	6 ÷ 24	13,9 ÷ 8,3
40-200AP	■	-	-	■	■	9 ÷ 45	61,4 ÷ 42,2	■	■	6 ÷ 24	14,9 ÷ 9,4
40-250C	■	-	-	■	■	9 ÷ 36	64,4 ÷ 55,4	■	■	9 ÷ 27	15,2 ÷ 6,6
40-250B	■	-	-	■	■	9 ÷ 39	79,9 ÷ 62,1	■	■	9 ÷ 30	18,2 ÷ 8,3
40-250A1	■	-	-	-	-	9 ÷ 42	84,6 ÷ 72,8	-	-	-	-
40-250A	■	-	-	■	■	9 ÷ 45	84,6 ÷ 69	■	■	9 ÷ 33	20,8 ÷ 8,4
40-250BM	■	-	-	■	■	9 ÷ 54	93,2 ÷ 72	-	-	-	-
40-250AM	■	-	-	■	■	9 ÷ 60	103 ÷ 77,5	-	-	-	-
50-125B	■	-	-	■	■	12 ÷ 72	20,6 ÷ 9,2	■	■	9 ÷ 42	5,5 ÷ 2,1
50-125A	■	-	-	■	■	12 ÷ 72	24,3 ÷ 14,2	■	■	9 ÷ 45	6,4 ÷ 2,9
50-160B1	■	-	-	-	-	21 ÷ 66	33,5 ÷ 21,5	-	-	-	-
50-160B	■	-	-	■	■	21 ÷ 72	33,5 ÷ 18,9	■	■	9 ÷ 42	8 ÷ 2,3
50-160A1	■	-	-	-	-	21 ÷ 72	39,8 ÷ 27,6	-	-	-	-
50-160A	■	-	-	■	■	21 ÷ 78	39,8 ÷ 25,4	■	■	9 ÷ 48	9,4 ÷ 3,1
50-200C	■	-	-	■	■	24 ÷ 72	49,7 ÷ 28,9	■	■	9 ÷ 39	12 ÷ 3,2
50-200B	■	-	-	■	■	24 ÷ 72	54,6 ÷ 35	■	■	10,5 ÷ 42	13,1 ÷ 4,2
50-200A1	■	-	-	-	-	24 ÷ 78	61,8 ÷ 39,8	-	-	-	-



TYPE	2 POLES						4 POLES					
	CM	CMG	CMGX	CA	CAT CAX CATX	Flow rate	Head	4CA 4CAT	4CAX 4CATX	Flow rate	Head	
						m <sup>3</sup> /h	m			m <sup>3</sup> /h	m	
50-200A	■	-	-	■	■	24 ÷ 78	61,8 ÷ 39,8	■	■	10,5 ÷ 45	14,7 ÷ 4,6	
50-250C1	■	-	-	-	-	27 ÷ 60	68,2 ÷ 56,2	-	-	-	-	
50-250C	■	-	-	■	■	27 ÷ 66	68,2 ÷ 52,1	■	■	12 ÷ 45	17,7 ÷ 7,5	
50-250B	■	-	-	■	■	27 ÷ 72	78,4 ÷ 58,5	■	■	12 ÷ 48	20 ÷ 8,2	
50-250A	■	-	-	■	■	27 ÷ 78	88,3 ÷ 61,8	■	■	12 ÷ 54	22,9 ÷ 8,4	
50-315DN	-	-	-	■	-	42 ÷ 132	90,4 ÷ 73,4	-	-	-	-	
50-315C	-	-	-	-	-	-	-	■	■	18 ÷ 84	24,7 ÷ 16,8	
50-315CN	-	-	-	■	-	42 ÷ 132	105 ÷ 88,7	-	-	-	-	
50-315B	-	-	-	-	-	-	-	■	■	18 - 90	31,4 - 21,6	
50-315BN	-	-	-	■	-	42 ÷ 144	124,3 ÷ 103,5	-	-	-	-	
50-315A	-	-	-	-	-	-	-	■	■	18 - 96	37,2 - 25,1	
50-315AN	-	-	-	■	-	42 ÷ 144	146,9 ÷ 125,8	-	-	-	-	
65-125B1	■	-	-	-	-	30 ÷ 108	20,6 ÷ 15	-	-	-	-	
65-125B	■	-	-	■	■	30 ÷ 120	20,6 ÷ 13,1	■	■	18 ÷ 60	5,1 ÷ 2,8	
65-125A1	■	-	-	-	-	30 ÷ 120	25,2 ÷ 18,8	-	-	-	-	
65-125A	■	-	-	■	■	30 ÷ 132	25,2 ÷ 16,8	■	■	18 ÷ 72	6,3 ÷ 3	
65-160C	■	-	-	■	■	42 ÷ 144	30,6 ÷ 13,9	■	■	24 ÷ 78	7,6 ÷ 2,9	
65-160B	■	-	-	■	■	42 ÷ 144	35,1 ÷ 20,4	■	■	24 ÷ 78	8,6 ÷ 3,6	
65-160A1	■	-	-	-	-	42 ÷ 138	42,5 ÷ 31,7	-	-	-	-	
65-160A	■	-	-	■	■	42 ÷ 144	42,5 ÷ 30,9	■	■	24 ÷ 84	9,9 ÷ 4,6	
65-200C1	■	-	-	-	-	54 ÷ 132	46,1 ÷ 28,9	-	-	-	-	
65-200C	■	-	-	■	■	54 ÷ 138	46,1 ÷ 26,8	■	■	27 ÷ 84	11,6 ÷ 5	
65-200B	■	-	-	■	■	54 ÷ 144	53,9 ÷ 34,6	■	■	27 ÷ 84	13,1 ÷ 7	
65-200A	■	-	-	■	■	54 ÷ 144	61,8 ÷ 44,4	■	■	27 ÷ 84	14,8 ÷ 9,3	
65-250B	■	-	-	■	■	54 ÷ 144	80,6 ÷ 47,3	■	■	27 ÷ 84	21 ÷ 8,7	
65-250A	■	-	-	■	■	54 ÷ 150	91,6 ÷ 57,9	■	■	30 ÷ 90	22,9 ÷ 8,8	
65-315CM	-	-	-	-	-	-	-	■	■	27 ÷ 126	23,5 ÷ 13,9	
65-315CN	-	-	-	■	-	54 ÷ 180	96,5 ÷ 80,8	-	-	-	-	
65-315BM	-	-	-	-	-	-	-	■	■	27 ÷ 132	28,9 ÷ 17,2	
65-315BN	-	-	-	■	-	54 ÷ 195	117,9 ÷ 96,3	-	-	-	-	
65-315AM	-	-	-	-	-	-	-	■	■	27 ÷ 138	34 ÷ 18,2	
65-315AN	-	-	-	■	-	54 ÷ 210	138,8 ÷ 110,4	-	-	-	-	
80-160E	■	-	-	■	■	66 ÷ 168	22,9 ÷ 13,7	■	■	24 ÷ 96	5,7 ÷ 2,2	
80-160D	■	-	-	■	■	66 ÷ 180	27,3 ÷ 16,4	■	■	27 ÷ 102	6,8 ÷ 2,6	
80-160C1	■	-	-	-	-	66 ÷ 195	30,9 ÷ 18,4	-	-	-	-	
80-160C	■	-	-	■	■	66 ÷ 195	30,9 ÷ 18,4	■	■	30 ÷ 108	7,4 ÷ 3,1	
80-160B	■	-	-	■	■	66 ÷ 210	35,9 ÷ 22	■	■	33 ÷ 120	8,9 ÷ 3,5	
80-160A	■	-	-	■	■	66 ÷ 225	40,5 ÷ 23,9	■	■	36 ÷ 132	9,8 ÷ 3,8	
80-200B	■	-	-	■	■	72 ÷ 225	54,5 ÷ 38,5	■	■	42 ÷ 132	13,1 ÷ 7,1	
80-200A	■	-	-	■	■	72 ÷ 240	61,7 ÷ 43,9	■	■	42 ÷ 144	14,7 ÷ 7,5	
80-250B	-	■	■	■	■	96 ÷ 225	80 ÷ 58,8	■	■	42 ÷ 132	19,2 ÷ 11,1	
80-250A	-	■	■	■	■	96 ÷ 240	92,8 ÷ 65,2	■	■	42 ÷ 144	22,9 ÷ 12,6	
80-315B	-	-	-	-	-	-	-	■	■	42 ÷ 150	28,3 ÷ 19,9	
80-315BN	-	-	-	■	-	78 ÷ 255	112,4 ÷ 90,8	-	-	-	-	
80-315A	-	-	-	-	-	-	-	■	■	42 ÷ 168	35 ÷ 23,7	
80-315AN	-	-	-	■	-	78 ÷ 255	141,4 ÷ 118,5	-	-	-	-	
100-160B	■	-	-	-	-	96 ÷ 330	40,7 ÷ 25,7	-	-	-	-	
100-160A	■	-	-	-	-	96 ÷ 330	45,1 ÷ 31,9	-	-	-	-	
100-200D	-	-	-	■	■	108 ÷ 300	43,1 ÷ 26,6	■	■	48 ÷ 168	10,8 ÷ 4,8	
100-200C	-	-	-	■	■	108 ÷ 330	48,4 ÷ 28,1	■	■	48 ÷ 168	12 ÷ 6,3	
100-200B	-	■	■	■	■	108 ÷ 330	56,8 ÷ 39,7	■	■	48 ÷ 180	13,6 ÷ 7,8	
100-200A	-	■	■	■	■	108 ÷ 360	62,2 ÷ 42,5	■	■	48 ÷ 192	15,4 ÷ 9,1	
100-250E	-	-	-	-	-	-	-	■	■	60 ÷ 180	16,9 ÷ 11,4	
100-250D	-	-	-	-	-	-	-	■	■	60 ÷ 192	19,6 ÷ 12,7	



TYPE	2 POLES						4 POLES					
	CM	CMG	CMGX	CA	CAT CAX CATX	Flow rate	Head	4CA 4CAT	4CAX 4CATX	Flow rate	Head	
						m <sup>3</sup> /h	m			m <sup>3</sup> /h	m	
100-250C	-	■	■	■	■	120 ÷ 300	73,2 ÷ 61	-	-	-	-	
100-250B	-	■	■	■	■	120 ÷ 330	83,7 ÷ 67,6	-	-	-	-	
100-250A	-	■	■	■	■	120 ÷ 360	93,9 ÷ 73,2	■	■	60 ÷ 204	22,3 ÷ 13,8	
100-315B	-	-	-	-	-	-	-	■	■	72 ÷ 216	31,4 ÷ 17,9	
100-315A	-	-	-	-	-	-	-	■	■	72 ÷ 216	36,5 ÷ 23,1	
100-400C	-	-	-	-	-	-	-	■	■	84 ÷ 228	40,6 ÷ 25,8	
100-400B	-	-	-	-	-	-	-	■	■	84 ÷ 240	48,7 ÷ 31,6	
100-400A	-	-	-	-	-	-	-	■	■	84 ÷ 252	56 ÷ 36,7	
125-250B	-	-	-	-	-	-	-	■	■	102 ÷ 252	20,2 ÷ 11,1	
125-250A	-	-	-	-	-	-	-	■	■	102 ÷ 276	24 ÷ 14,7	
125-315C	-	-	-	-	-	-	-	■	■	120 ÷ 348	25,8 ÷ 15,7	
125-315B	-	-	-	-	-	-	-	■	■	120 ÷ 372	33 ÷ 22,2	
125-315A	-	-	-	-	-	-	-	■	■	120 ÷ 372	39,6 ÷ 28,2	
125-400C	-	-	-	-	-	-	-	■	■	120 ÷ 372	47,6 ÷ 33,8	
125-400B	-	-	-	-	-	-	-	■	■	120 ÷ 396	54,5 ÷ 39,1	
125-400A	-	-	-	-	-	-	-	■	■	120 ÷ 396	59,5 ÷ 45	
150-315D	-	-	-	-	-	-	-	■	■	144 ÷ 444	28,3 ÷ 19,6	
150-315C	-	-	-	-	-	-	-	■	■	144 ÷ 492	32,2 ÷ 21,8	
150-315B	-	-	-	-	-	-	-	■	■	144 ÷ 540	36,3 ÷ 23,6	
150-315A	-	-	-	-	-	-	-	■	■	144 ÷ 564	41 ÷ 27,2	
150-400C	-	-	-	-	-	-	-	■	■	168 ÷ 564	47,8 ÷ 28,7	
150-400B	-	-	-	-	-	-	-	■	■	168 ÷ 588	54,4 ÷ 34,3	
150-400A	-	-	-	-	-	-	-	■	■	168 ÷ 612	60,3 ÷ 39,8	
<b>Not envisaged in the EN 733 standard</b>												
200-315D	-	-	-	-	-	-	-	■	■	200 ÷ 800	21,7 ÷ 12,5	
200-315C	-	-	-	-	-	-	-	■	■	200 ÷ 850	26,6 ÷ 14,6	
200-315B	-	-	-	-	-	-	-	■	■	200 ÷ 900	33,4 ÷ 16,7	
200-315A	-	-	-	-	-	-	-	■	■	200 ÷ 900	35,9 ÷ 19,8	
200-400C	-	-	-	-	-	-	-	■	■	200 ÷ 800	44,1 ÷ 31,5	
200-400B	-	-	-	-	-	-	-	■	■	200 ÷ 850	50,8 ÷ 36,6	
200-400A	-	-	-	-	-	-	-	■	■	200 ÷ 900	58,5 ÷ 44	
250-315C	-	-	-	-	-	-	-	■	■	250 ÷ 1100	25,5 ÷ 16,8	
250-315B	-	-	-	-	-	-	-	■	■	250 ÷ 1170	33 ÷ 19	
250-315A	-	-	-	-	-	-	-	■	■	250 ÷ 1200	35 ÷ 20	
250-400D	-	-	-	-	-	-	-	■	■	250 ÷ 1300	39,9 ÷ 24,3	
250-400C	-	-	-	-	-	-	-	■	■	250 ÷ 1400	45,8 ÷ 27,4	
250-400B	-	-	-	-	-	-	-	■	■	250 ÷ 1500	51,7 ÷ 30,3	
250-400A	-	-	-	-	-	-	-	■	■	250 ÷ 1600	57,4 ÷ 31,7	



# CM Series

## Models list and materials

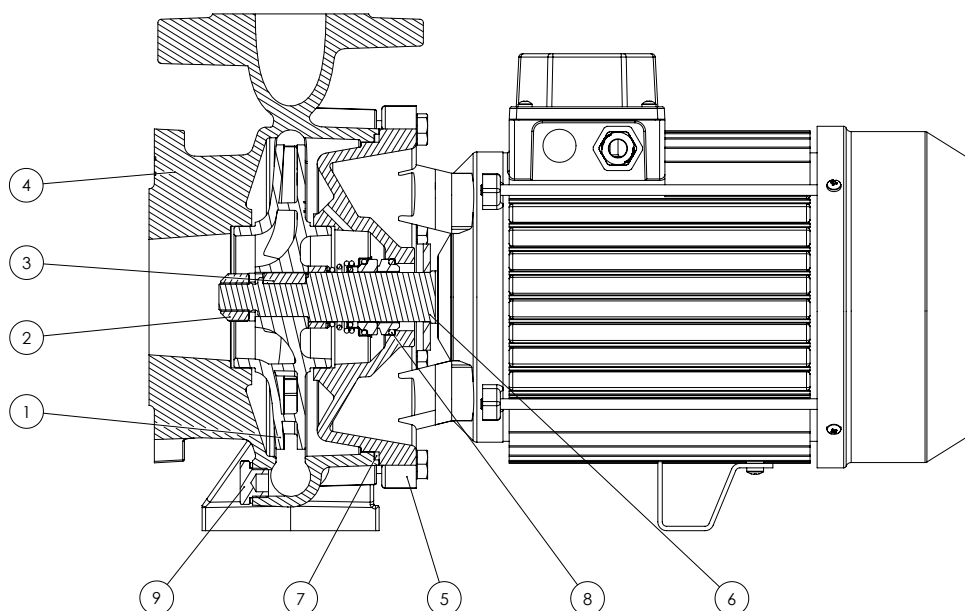

POS. N.	DENOMINATION	VERSION	MATERIAL	REFERENCE STANDARDS	
				EUROPE	USA
1	<b>Impeller</b>	Standard	Cast iron G20	GJL-200 (JL1030)	ASTM Class 30
		B	Bronze	CuSn10-C (CC480K)	UNS C90700
		X	Stainless steel	X5CrNiMo17-12-2/ 1.4401	AISI 316
2	<b>Impeller lock nut and washer</b>		Stainless steel	X5CrNiMo17-12-2/ 1.4401	AISI 316
3	<b>Impeller key</b>		Stainless steel	X5CrNiMo17-12-2/ 1.4401	AISI 316
4	<b>Volute casing</b>	Up to 80-200	Cast iron G20	GJL-200 (JL1030)	ASTM Class 30
		From 80-250	Cast iron G25	GJL-250 (JL1040)	ASTM Class 35
5	<b>Motor bracket</b>		Cast iron G20	GJL-200 (JL1030)	ASTM Class 30
6	<b>Shaft extension</b>		Stainless steel	X5CrNi18-10/ 1.4301	AISI 304
7	<b>O-ring</b>	Standard	NBR		
		E	EPDM		
		V	FKM		
8	<b>Mechanical seal</b>		(Search for the material in the mechanical seal table)		
9	<b>Fill and drain plugs</b>		Brass	CU ZN 40 PB2 UNI 5705/65	C37700

TYPE	P2		1~				3~				Q (m³/h - l/min)								
			P <sub>1</sub> max kW	A 1~230V 50Hz	P <sub>1</sub> max kW	A 3~400V 50Hz	0	6	7,5	9	12	15	18	21	24	27	30	33	
	HP	kW					0	100	125	150	200	250	300	350	400	450	500	550	
	H (m)																		
<b>32-160C</b>	2	1,5	2,0	9,3	1,9	3,6	23,0	22,8	22,5	22,0	21,0	19,2	16,9	14,0					
<b>32-160B</b>	3	2,2	2,7	12,4	2,6	4,9	28,0	27,7	27,4	27,0	26,2	24,9	22,9	20,1	17,0				
<b>32-160A</b>	4	3	-	-	3,8	6,8	36,1	36,2	36,0	35,6	34,6	33,2	31,4	28,9	25,7	22,1			
<b>32-200C</b>	5,5	4	5,2	22,9	4,9	8,9	40,2	40,3	40,1	39,8	38,9	37,7	36,1	34,2	31,6	28,7			
<b>32-200B1</b>	7,5	5,5	-	-	6,4	11,3	48,3	48,0	47,9	47,6	46,7	45,5	44,2	42,6	40,5	37,9			
<b>32-200B</b>	7,5	5,5	-	-	6,7	11,1	48,3	48,0	47,9	47,6	46,7	45,5	44,2	42,6	40,5	37,9	35,4		
<b>32-200A1</b>	10	7,5	-	-	8,2	14,5	57,9	58,3	58,4	58,4	58,0	57,1	55,6	53,8	51,4	49,2	46,6		
<b>32-200A</b>	10	7,5	-	-	8,6	14,1	57,9	58,3	58,4	58,4	58,0	57,1	55,6	53,8	51,4	49,2	46,6	44,3	
<b>32-250C</b>	12,5	9,2	-	-	10,0	16,8	74,6		72,8	72,5	71,9	70,5	68,8	66,6	64,1	61,3			
<b>32-250B</b>	15	11	-	-	12,2	20,0	84,8		84,0	83,9	83,6	82,7	81,1	78,6	75,4	73,2			
<b>32-250A1</b>	20	15	-	-	13,5	23,2	93,5		93,6	93,7	93,7	93,4	92,3	90,4	87,7	85,3			
<b>32-250A</b>	20	15	-	-	13,5	23,2	93,5		93,6	93,7	93,7	93,4	92,3	90,4	87,7	85,3			

TYPE	P2		1~				3~				Q (m³/h - l/min)													
			P <sub>1</sub> max kW	A 1~230V 50Hz	P <sub>1</sub> max kW	A 3~400V 50Hz	0	9	12	15	18	21	24	27	30	33	36	39	42	45	48	54	60	
	HP	kW					0	150	200	250	300	350	400	450	500	550	600	650	700	750	800	900	1000	
	H (m)																							
<b>40-125C</b>	2	1,5	2,0	9,3	1,9	3,6	17,9	18,5	18,4	18,1	17,5	16,6	15,6	14,3	12,8	11,1	9,4							
<b>40-125B</b>	3	2,2	2,7	12,4	2,6	4,9	22,6	23,4	23,3	23,1	22,7	22,0	21,0	19,9	18,6	17,0	15,1	13,2						
<b>40-125A</b>	4	3	-	-	3,6	6,5	26,8	27,6	27,7	27,6	27,2	26,5	25,7	24,6	23,4	22,0	20,3	18,5	16,8					
<b>40-160B</b>	4	3	3,8	16,7	3,8	6,8	28,2	29,2	29,2	28,9	28,3	27,5	26,5	25,3	23,8	22,3	20,5							
<b>40-160A</b>	5,5	4	5,0	22,5	4,9	8,8	33,8	34,9	34,8	34,5	33,9	33,2	32,4	31,3	30,0	28,5	26,9	25,2	23,4					
<b>40-160AP</b>	7,5	5,5	-	-	6,1	11,0	38,6	39,8	39,9	39,8	39,4	38,7	37,9	37,0	35,8	34,4	32,9	31,1	29,3	27,4	25,3			
<b>40-200B1</b>	7,5	5,5	-	-	6,8	12,0	44,7	45,5	45,4	45,0	44,5	43,5	42,3	41,0	39,3	37,2	34,9	32,3						
<b>40-200B</b>	7,5	5,5	-	-	6,9	11,4	44,6	45,5	45,4	45,0	44,5	43,5	42,3	41,0	39,3	37,2	34,9	32,3	29,4					
<b>40-200A1</b>	10	7,5	-	-	9,0	15,5	56,2	56,5	56,5	56,3	55,9	55,1	54,1	52,8	51,2	49,3	47,0	44,4						
<b>40-200A</b>	10	7,5	-	-	9,3	15,1	56,2	56,5	56,5	56,3	55,9	55,1	54,1	52,8	51,2	49,3	47,0	44,4	41,6					
<b>40-200AP</b>	12,5	9,2	-	-	10,2	16,8	61,7	61,4	61,2	60,8	60,0	59,1	57,9	56,4	54,7	53,1	51,1	48,5	45,5	42,2				
<b>40-250C</b>	12,5	9,2	-	-	11,1	18,0	64,8	64,4	64,2	63,8	63,4	62,7	61,9	61,0	59,8	57,9	55,4							
<b>40-250B</b>	15	11	-	-	13,8	22,3	73,7	73,9	74,5	73,2	71,9	71,1	70,2	69,2	68,1	66,7	64,7	62,1						
<b>40-250A1</b>	20	15	-	-	16,5	27,2	82,6	84,6	84,8	84,7	84,3	83,4	82,4	81,3	80,0	78,5	76,9	75,4	72,8					
<b>40-250A</b>	20	15	-	-	17,5	29,1	82,6	84,6	84,8	84,7	84,3	83,4	82,4	81,3	80,0	78,5	76,9	75,4	72,8	69,0				
<b>40-250BM</b> max 14 bar	25	18,5	-	-	20,6	34,1	92,6	93,2	93,3	93,2	93,1	92,8	92,4	91,7	90,9	89,8	88,3	86,5	84,6	82,3	79,5	72,0		
<b>40-250AM</b> max 14 bar	30	22	-	-	24,4	40,3	101,7	103,0	102,8	102,3	102,0	101,7	101,2	100,4	99,4	98,1	96,5	94,8	93,1	90,9	85,0	77,5		

TYPE	P2		1~				3~				Q (m³/h - l/min)															
			P <sub>1</sub> max kW	A 1~230V 50Hz	P <sub>1</sub> max kW	A 3~400V 50Hz	0	12	15	18	21	24	27	30	33	36	39	42	45	48	54	60	66	72	78	
	HP	kW					0	200	250	300	350	400	450	500	550	600	650	700	750	800	900	1000	1100	1200	1300	
	H (m)																									
<b>50-125B</b>	4	3	3,6	16,1	3,8	6,8	20,0	20,6	20,6	20,4	20,3	20,1	19,9	19,6	19,2	18,7	18,2	17,6	17,0	16,4	15,0	13,2	11,3	9,2		
<b>50-125A</b>	5,5	4	5,0	22,5	4,8	8,8	23,7	24,3	24,3	24,2	24,1	23,9	23,7	23,3	23,0	22,6	22,1	21,7	21,2	20,7	19,6	18,2	16,4	14,2		
<b>50-160B1</b>	7,5	5,5	-	-	6,5	11,4	32,1				33,5	33,4	33,1	32,7	32,2	31,6	31,0	30,2	29,1	28,3	26,2	23,9	21,5			
<b>50-160B</b>	7,5	5,5	-	-	6,5	10,9	32,1				33,5	33,4	33,1	32,7	32,2	31,6	31,0	30,2	29,1	28,3	26,2	23,9	21,5	18,9		
<b>50-160A1</b>	10	7,5	-	-	8,6	15,1	38,1				39,8	39,8	39,7	39,5	39,2	38,8	38,3	37,7	36,7	36,0	34,2	32,2	29,7	27,4		
<b>50-160A</b>	10	7,5	-	-	8,8	14,4	38,1				39,8	39,8	39,7	39,5	39,2	38,8	38,3	37,7	36,7	36,0	34,2	32,2	29,7	27,4	25,4	
<b>50-200C</b>	12,5	9,2	-	-	10,4	17,2	48,2					49,7	49,2	48,5	47,7	46,9	45,9	44,9	43,7	42,6	40,0	36,0	32,3	28,9		
<b>50-200B</b>	15	11	-	-	11,9	19,5	53,1					54,6	54,1	53,5	52,9	52,2	51,4	50,4	49,3	48,1	45,5	42,7	38,8	35,0		
<b>50-200A1</b>	20	15	-	-	14,6	24,7	59,9					61,8	61,5	61,0	60,4	59,7	58,8	58,0	57,1	56,0	53,6	50,8	47,8	44,4	39,8	
<b>50-200A</b>	20	15	-	-	14,6	24,7	59,9					61,8	61,5	61,0	60,4	59,7	58,8	58,0	57,1	56,0	53,6	50,8	47,8	44,4	39,8	
<b>50-250C1</b>	20	15	-	-	16,1	26,6	69,2						68,2	67,7	67,0	66,3	65,6	64,7	63,8	62,8	59,9	56,2				
<b>50-250C</b>	20	15	-	-	17,2	28,6	69,2						68,2	67,7	67,0	66,3	65,6	64,7	63,8	62,8	59,9	56,2	52,1			
<b>50-250B</b>	25	18,5	-	-	20,7	34,3	78,8						78,4	78,0	77,6	77,0	76,1	75,1	74,0	72,9	70,3	66,9	62,9	58,5		
<b>50-250A</b>	30	22	-	-	24,8	40,9	88,5						88,3	88,1	87,7	87,2	86,6	85,8	84,8	83,8	81,4	78,5	75,0	70,2	64,8	



TYPE	P2		3-		Q (m <sup>3</sup> /h - l/min)																				
			P <sub>1</sub> max kW	A 3~400V 50Hz	0	30	33	36	39	42	45	48	54	60	66	72	78	84	96	108	120	132	138	144	150
	HP	kW	H (m)																						
65-125B1	7,5	5,5	6,4	11,3	19,7	20,6	20,5	20,4	20,4	20,3	20,2	20,2	20,0	19,7	19,3	18,8	18,2	17,5	16,3	15,0					
65-125B	7,5	5,5	6,6	11,0	19,7	20,6	20,5	20,4	20,4	20,3	20,2	20,2	20,0	19,7	19,3	18,8	18,2	17,5	16,3	15,0	13,1				
65-125A1	10	7,5	8,6	15,1	24,6	25,2	25,2	25,1	25,1	25,0	24,8	24,9	24,7	24,5	24,2	23,9	23,5	23,0	22,0	20,6	18,8				
65-125A	10	7,5	8,8	14,4	24,6	25,2	25,2	25,1	25,1	25,0	24,9	24,9	24,7	24,5	24,2	23,9	23,5	23,0	22,0	20,6	18,8	16,8			
65-160C	12,5	9,2	10,1	16,8	28,9					30,6	30,5	30,3	30,0	29,6	29,1	28,5	27,9	27,2	25,3	22,9	20,2	17,5	16,0	13,9	
65-160B	15	11	12,7	20,6	33,2					35,1	35,0	34,9	34,6	34,3	33,8	33,3	32,8	32,1	30,4	28,2	25,5	22,5	21,4	20,4	
65-160A1	20	15	16,8	27,6	40,1					42,5	42,5	42,5	42,3	42,1	41,8	41,4	41,0	40,4	38,9	37,1	35,3	32,8	31,7		
65-160A	20	15	17,1	28,5	40,1					42,5	42,5	42,5	42,3	42,1	41,8	41,4	41,0	40,4	38,9	37,1	35,3	32,8	31,7	30,9	
65-200C1	20	15	16,8	27,6	44,4								46,1	45,4	44,7	44,0	43,2	42,4	40,3	37,5	33,7	28,9			
65-200C	20	15	17,0	28,3	44,4								46,1	45,4	44,7	44,0	43,2	42,4	40,3	37,5	33,7	28,9	26,8		
65-200B	25	18,5	21,2	34,8	51,7								53,9	53,4	52,7	52,0	51,3	50,4	48,6	45,9	43,0	39,4	37,1	34,6	
65-200A	30	22	25,4	41,7	60,3								61,8	61,4	61,0	60,4	59,8	59,1	57,1	54,6	51,6	48,3	46,5	44,4	
65-250B	40	30	30,8	55,3	80,6								80,6	79,5	78,4	77,1	75,7	74,1	70,4	66,1	61,0	54,7	51,0	47,3	
65-250A	50	37	37,0	69,2	91,6								91,6	90,8	89,8	88,6	87,4	85,9	82,5	77,8	72,8	67,4	64,3	60,8	57,9

TYPE	P2		3-		Q (m <sup>3</sup> /h - l/min)																				
			P <sub>1</sub> max kW	A 3~400V 50Hz	0	66	72	78	84	96	108	120	132	138	144	156	168	180	195	210	225	240			
	HP	kW	H (m)																						
80-160E	12,5	9,2	9,8	16,3	21,5	22,9	22,5	22,1	21,6	20,8	19,9	18,9	17,7	17,2	16,6	15,3	13,7								
80-160D	15	11	12,2	20,0	25,4	27,3	27,0	26,6	26,3	25,4	24,5	23,5	22,4	21,8	21,2	19,9	18,3	16,4							
80-160C1	20	15	14,5	24,5	29,0	30,9	30,7	30,4	30,1	29,4	28,5	27,4	26,3	25,8	25,3	24,1	22,5	20,7	18,4						
80-160C	20	15	14,5	24,5	29,0	30,9	30,7	30,4	30,1	29,4	28,5	27,4	26,3	25,8	25,3	24,1	22,5	20,7	18,4						
80-160B	25	18,5	18,1	30,3	33,6	35,9	35,7	35,4	35,2	34,5	33,7	32,9	32,0	31,6	31,1	30,0	28,6	27,0	24,5	22,0					
80-160A	30	22	22	37	38	40,5	40,4	40,2	40,1	39,6	39,1	38,4	37,5	37,1	36,6	35,4	34,1	32,6	30,4	28,3	23,9				
80-200B	40	30	32,0	57,2	50,4				54,5	53,9	53,2	52,3	51,3	50,7	50,2	48,9	47,4	45,8	43,4	40,9	38,5				
80-200A	50	37	38,6	71,6	57,3				61,7	61,3	60,6	59,4	58,2	57,8	57,5	56,8	55,4	53,7	51,5	49,1	46,6	43,9			

TYPE	P2		3-		Q (m <sup>3</sup> /h - l/min)																				
			P <sub>1</sub> max kW	A 3~400V 50Hz	0	96	108	120	132	138	144	156	168	180	195	210	225	240	270	300	330				
	HP	kW	H (m)																						
100-160B	40	30	31,9	57,1	41,7	40,7	40,8	40,7	40,4	40,3	40,1	39,6	39,1	38,5	37,8	37,0	36,1	35,0	32,3	29,2	25,7				
100-160A	50	37	37,5	70,2	46,0	45,1	45,2	45,1	44,9	44,8	44,7	44,3	43,9	43,3	42,7	42,0	41,1	40,2	37,9	35,0	31,9				





# CM-CMG-CMGX-CA-CAX ~ EN 733

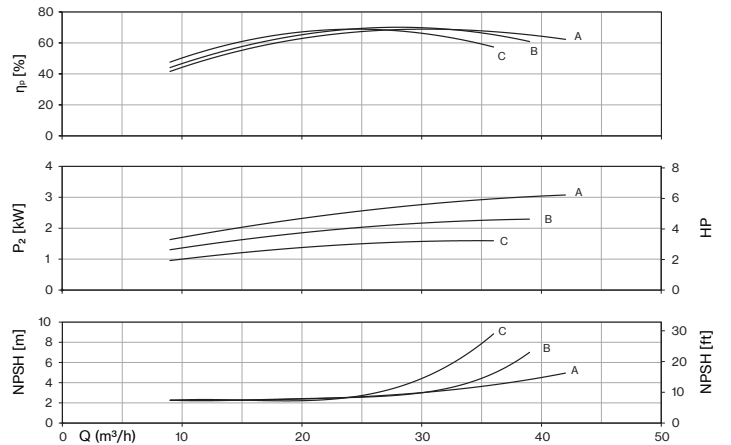
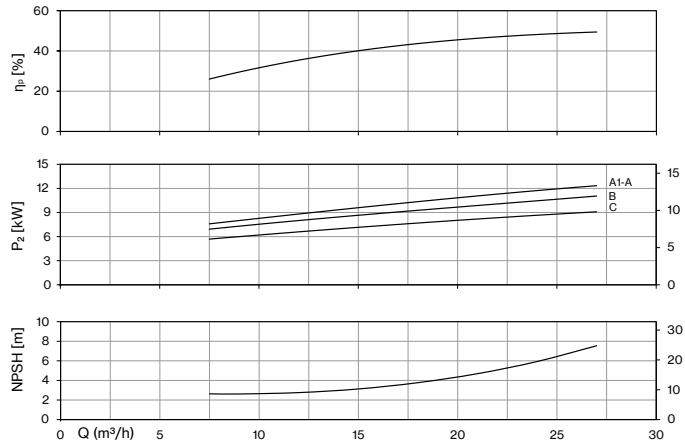
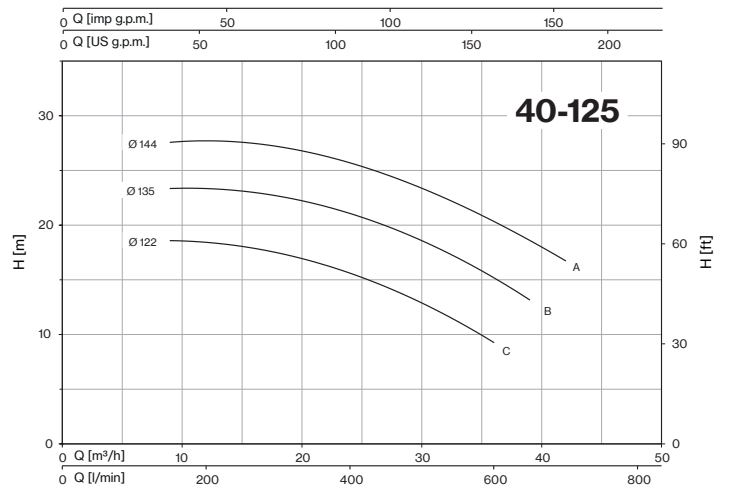
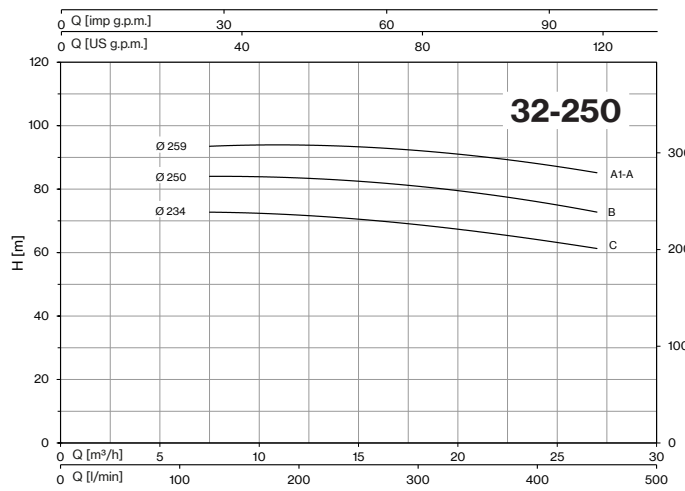
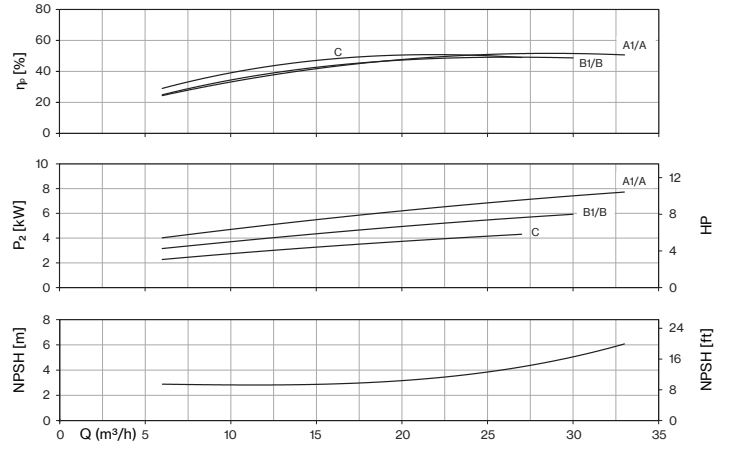
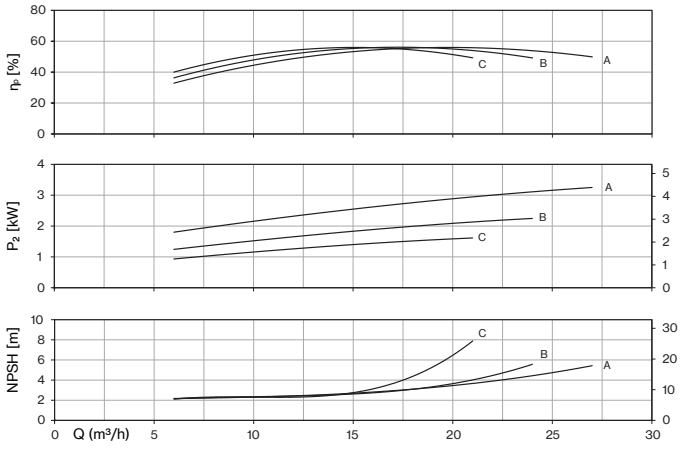
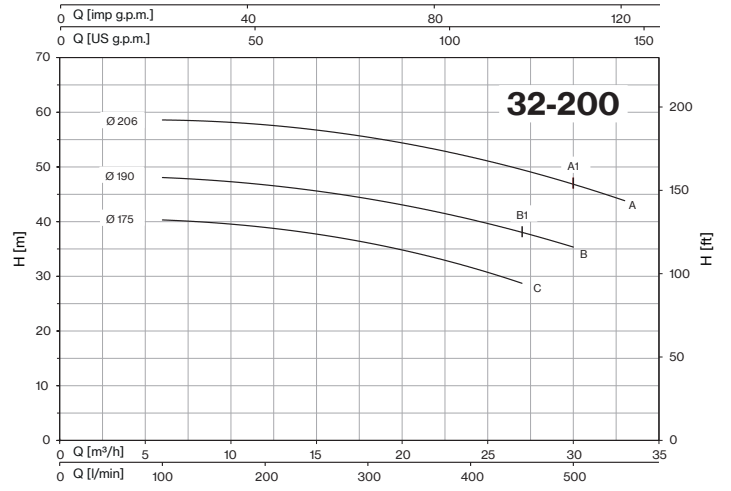
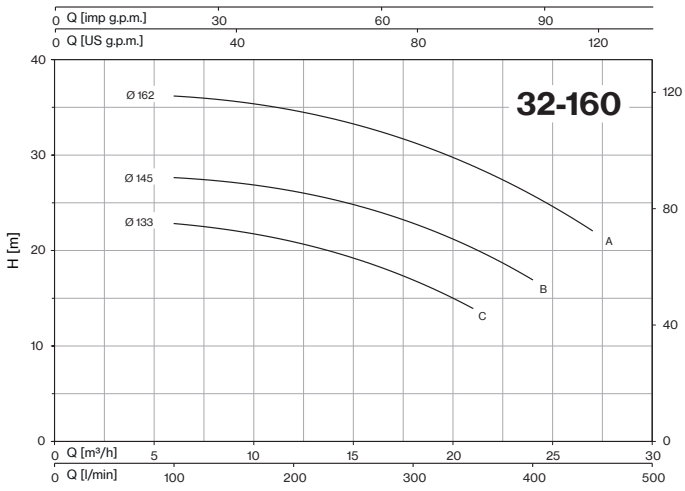

# CM-CMG-CMGX-CA-CAX ~ EN 733

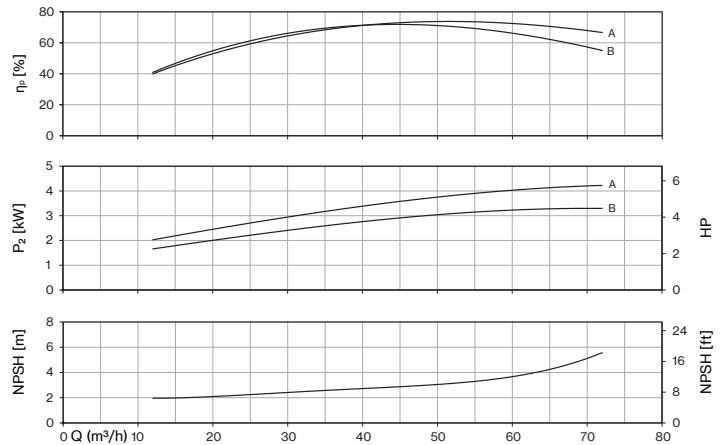
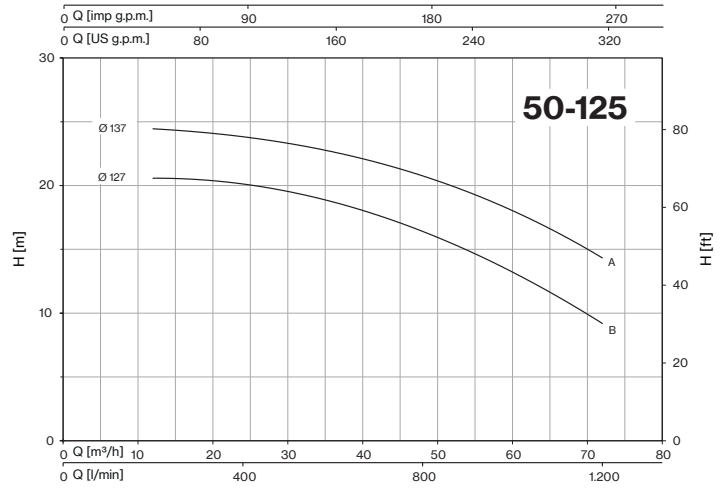
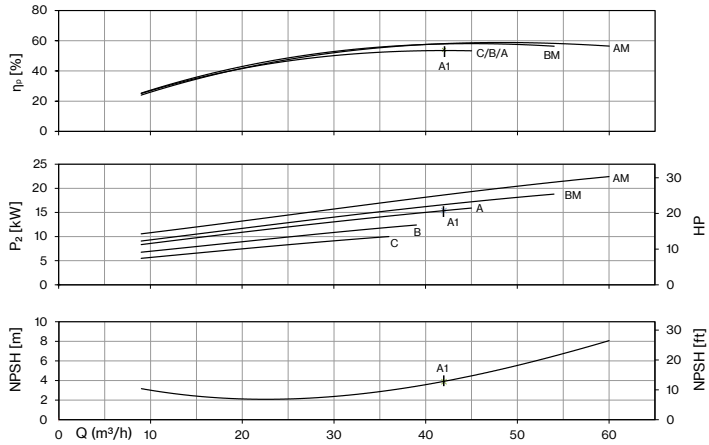
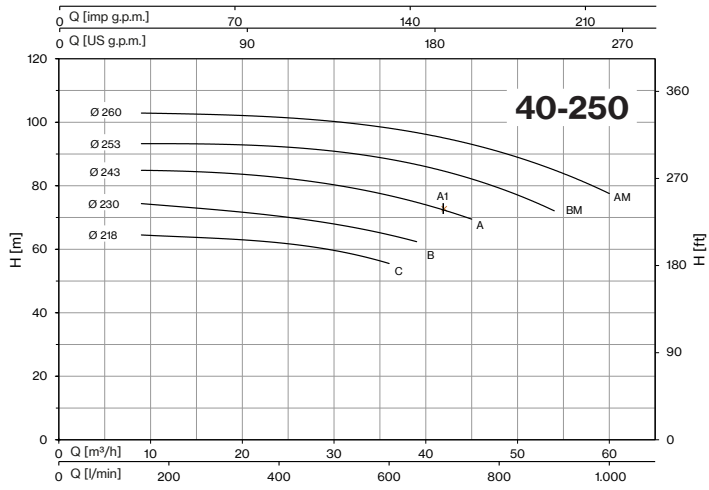
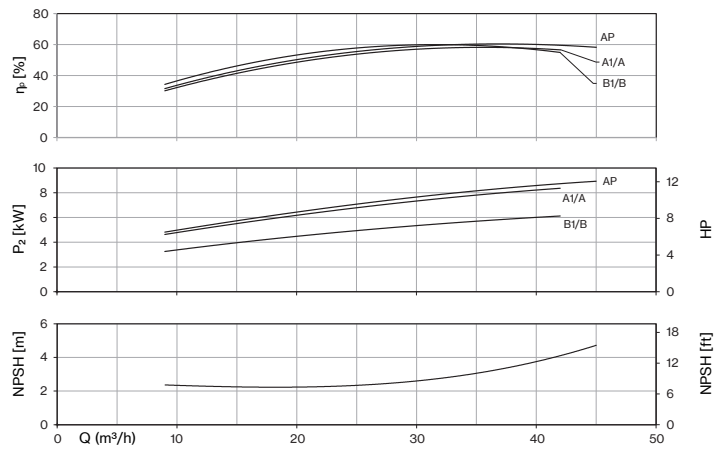
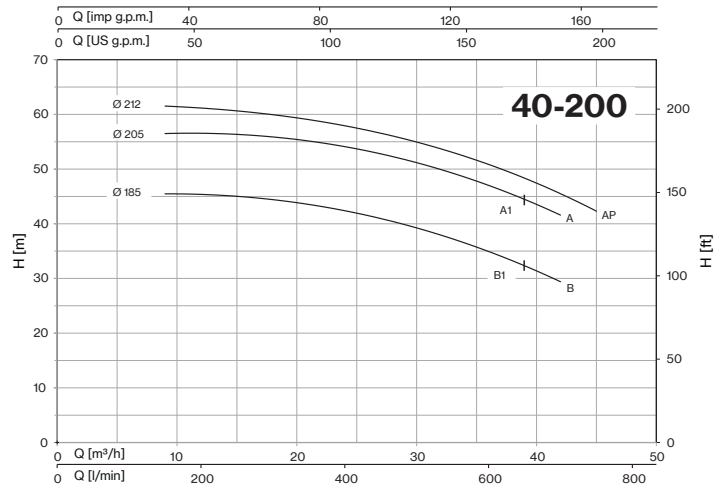
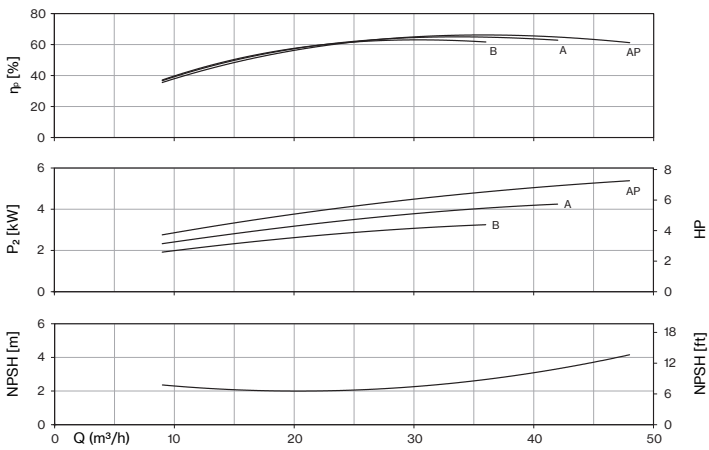
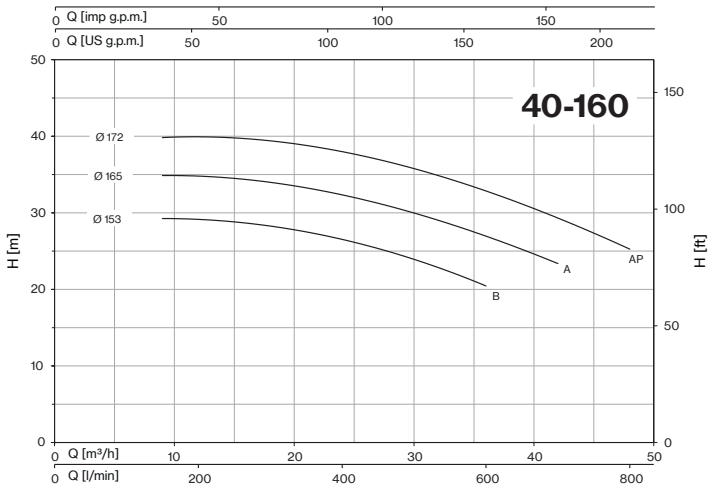

# CM-CMG-CMGX-CA-CAX ~ EN 733

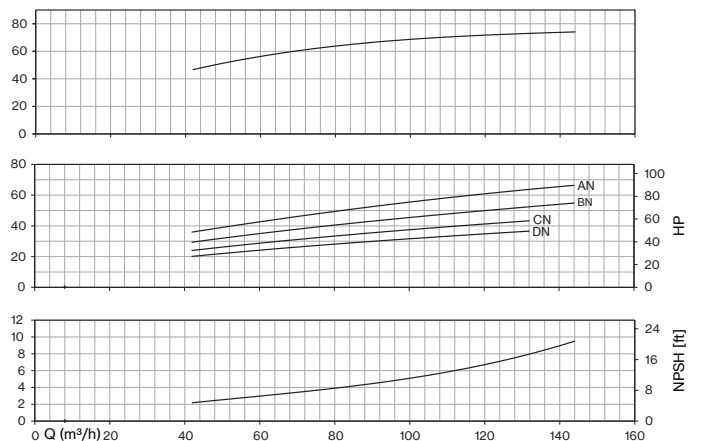
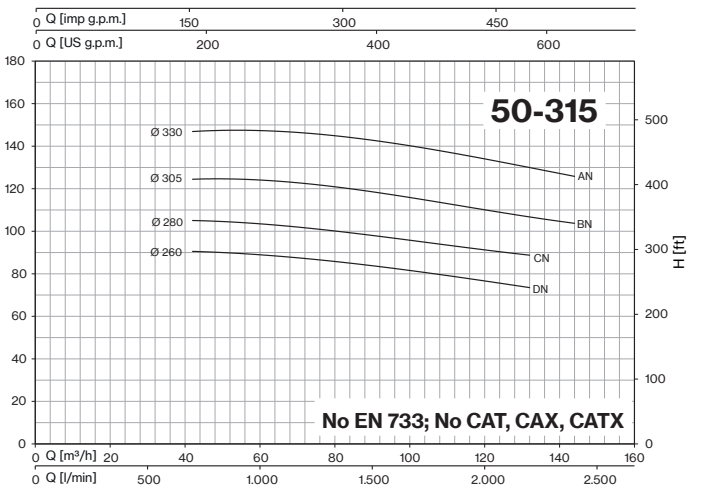
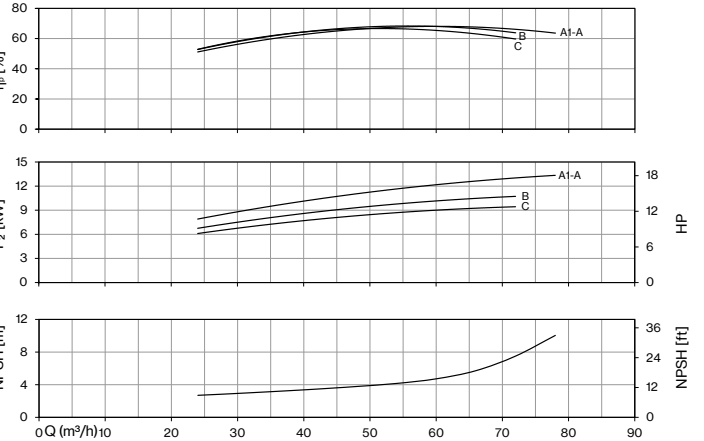
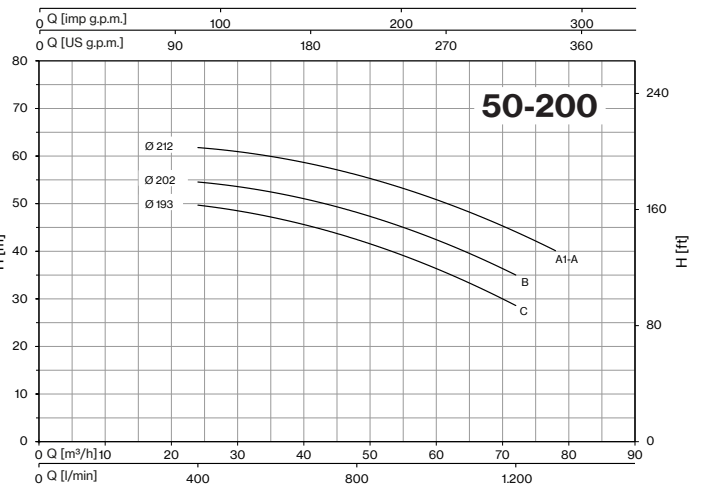
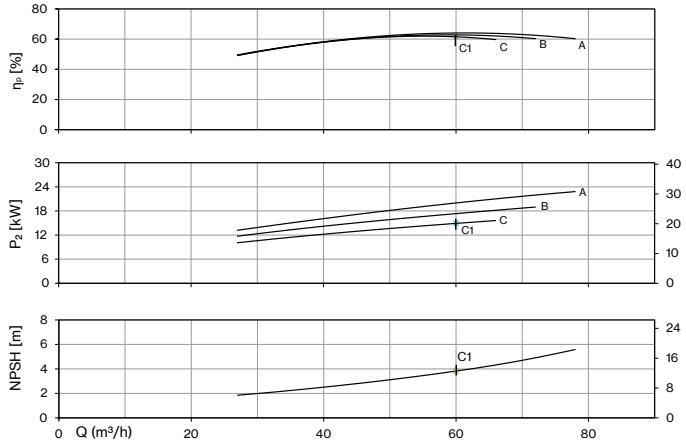
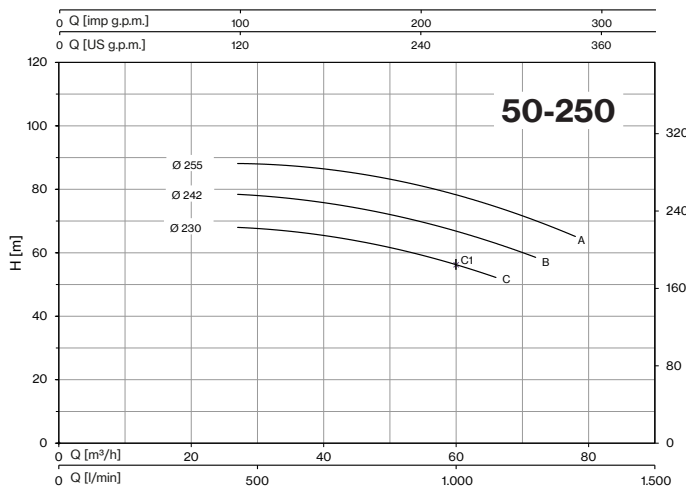
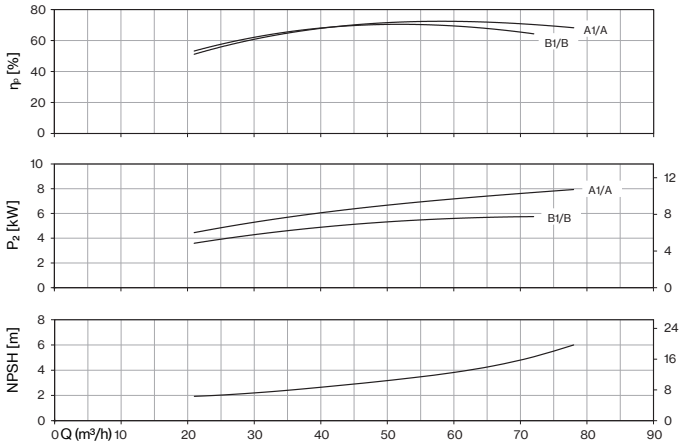
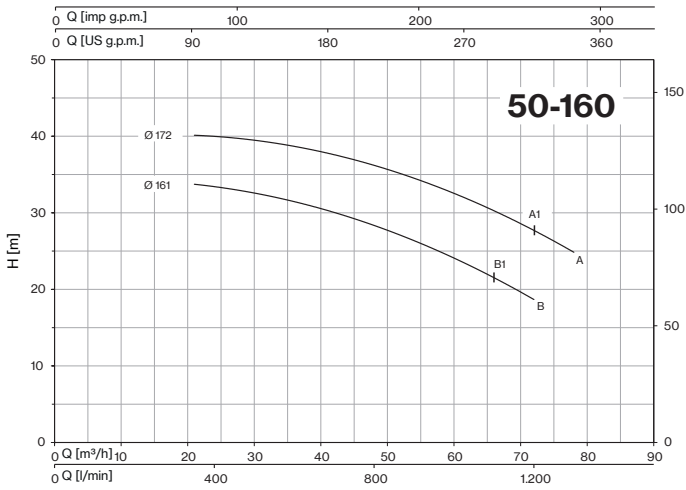

# CM-CMG-CMGX-CA-CAX ~ EN 733

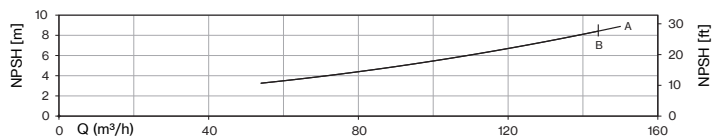
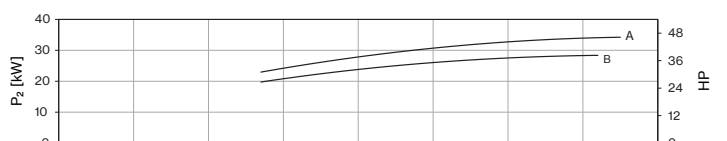
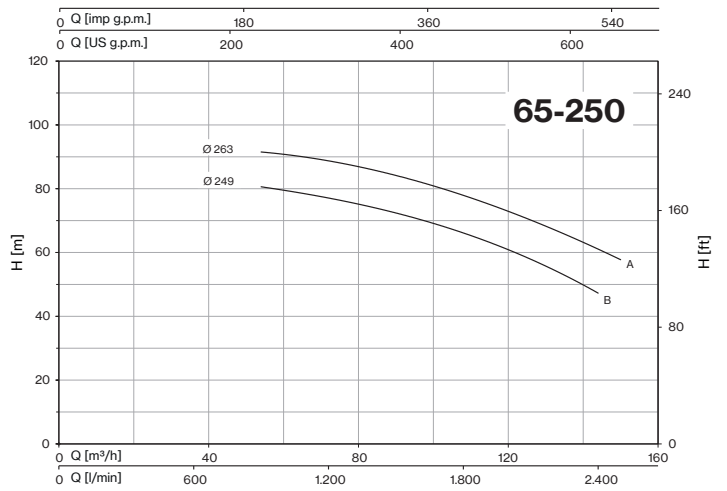
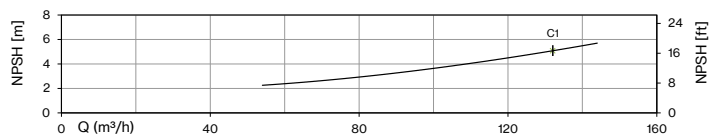
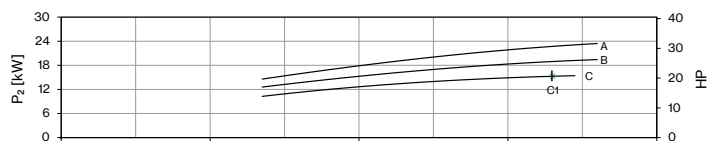
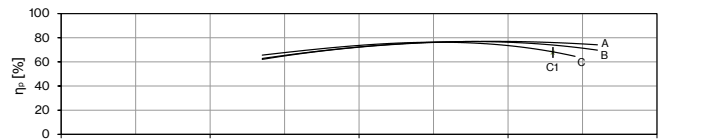
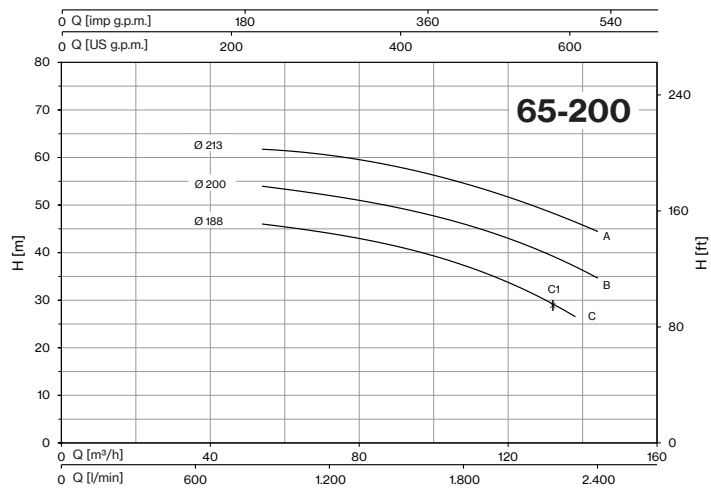
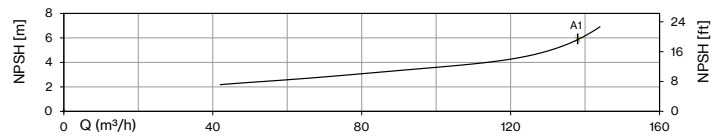
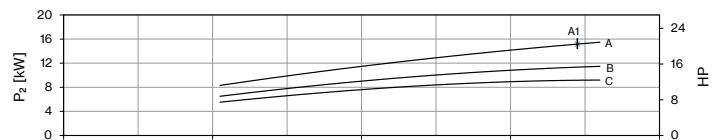
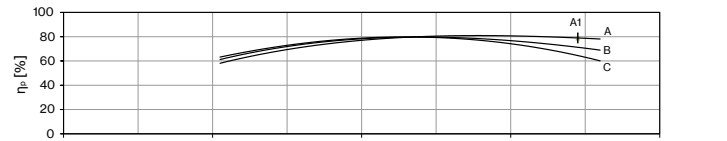
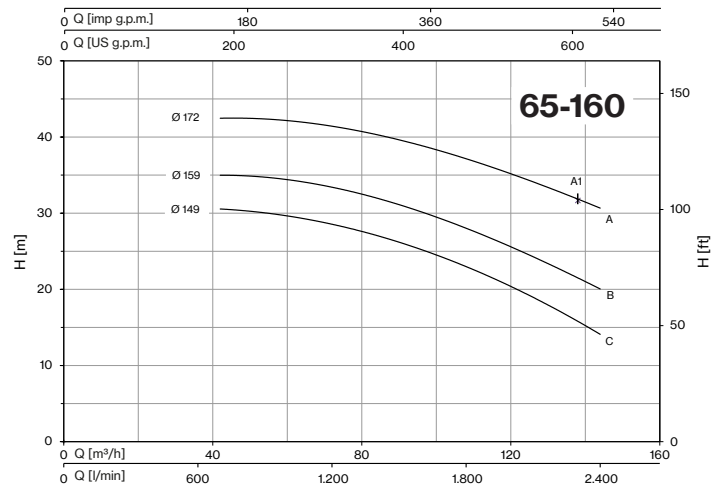
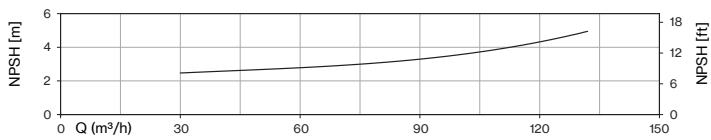
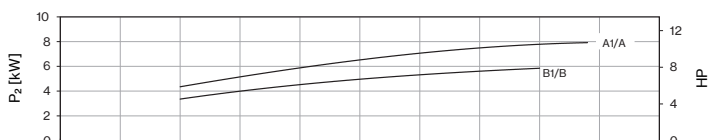
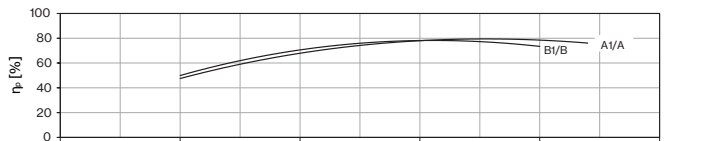
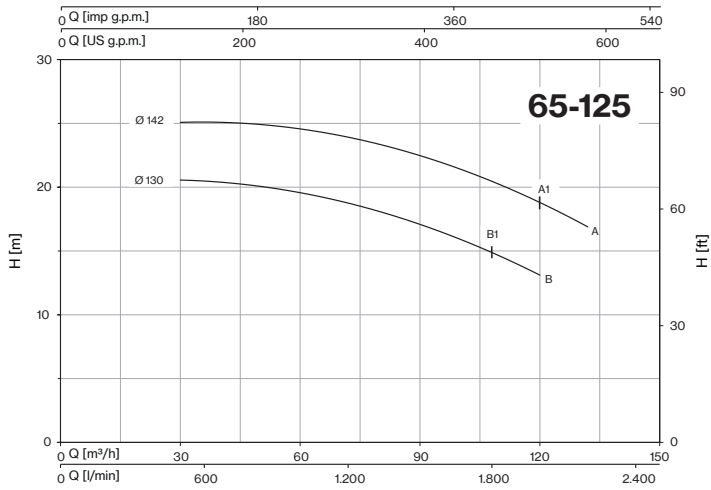

# CM-CMG-CMGX-CA-CAX ~ EN 733

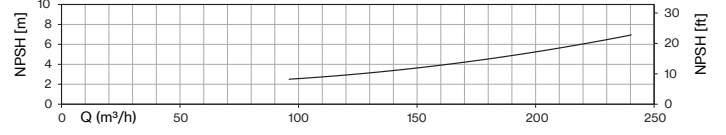
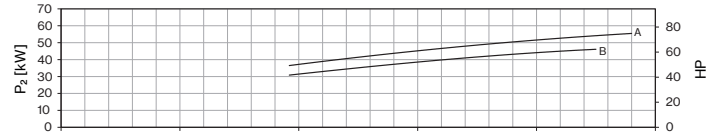
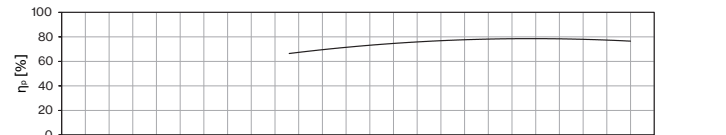
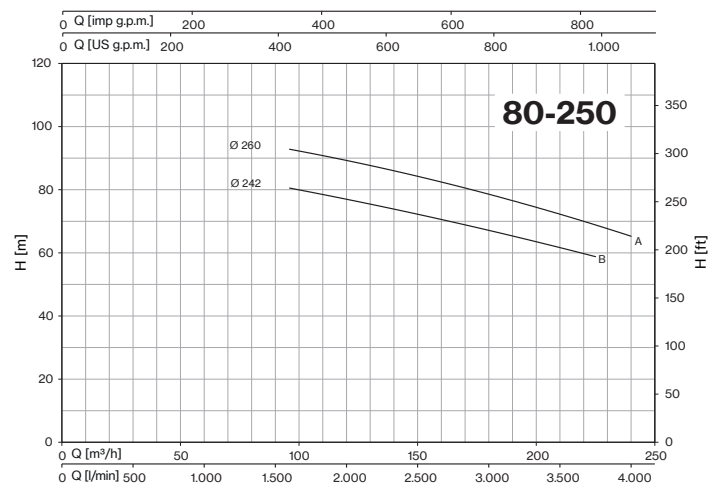
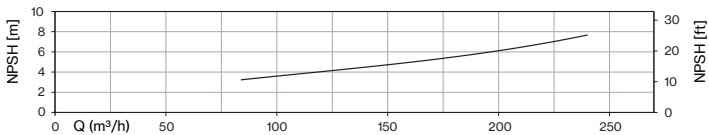
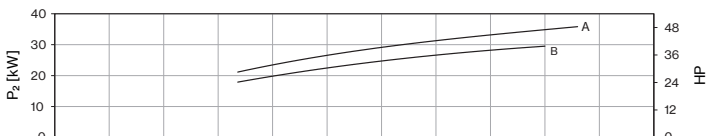
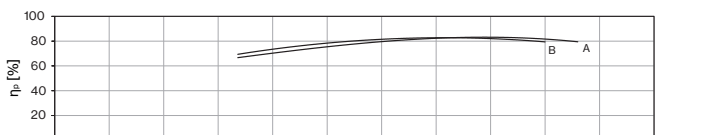
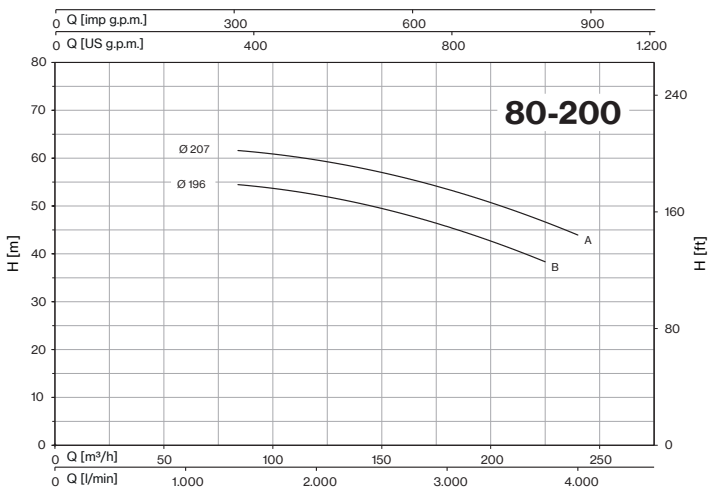
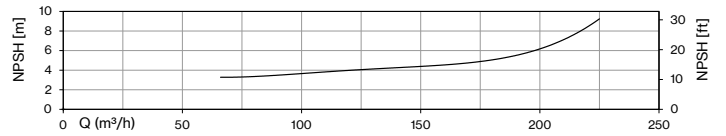
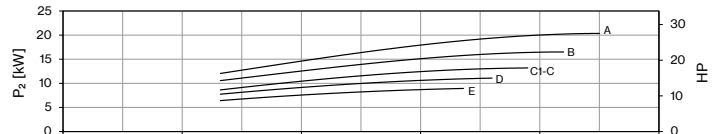
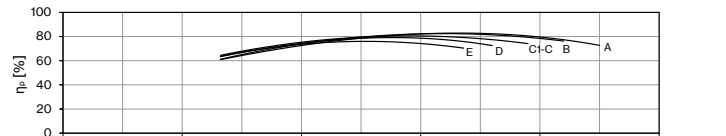
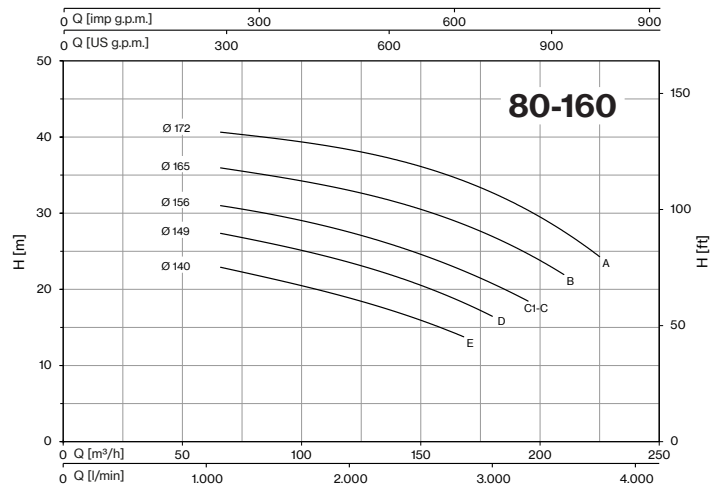
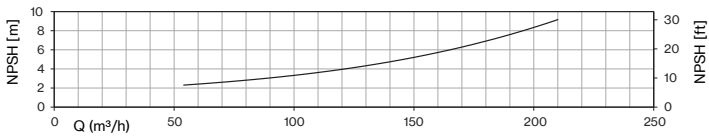
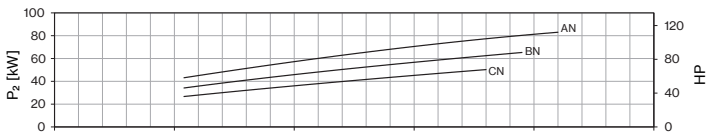
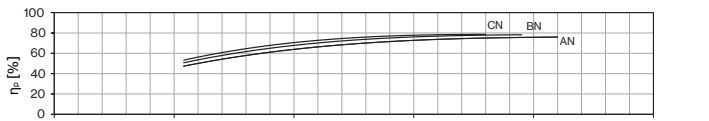
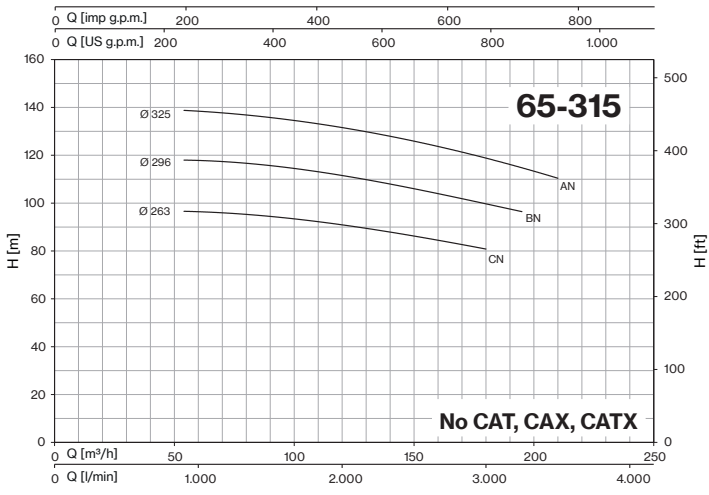

# CM-CMG-CMGX-CA-CAX ~ EN 733

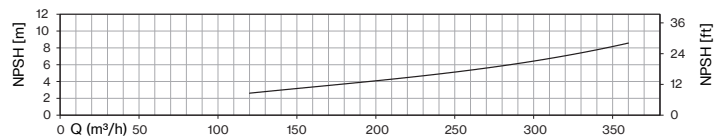
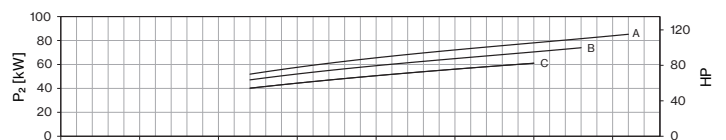
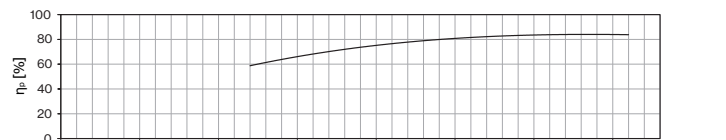
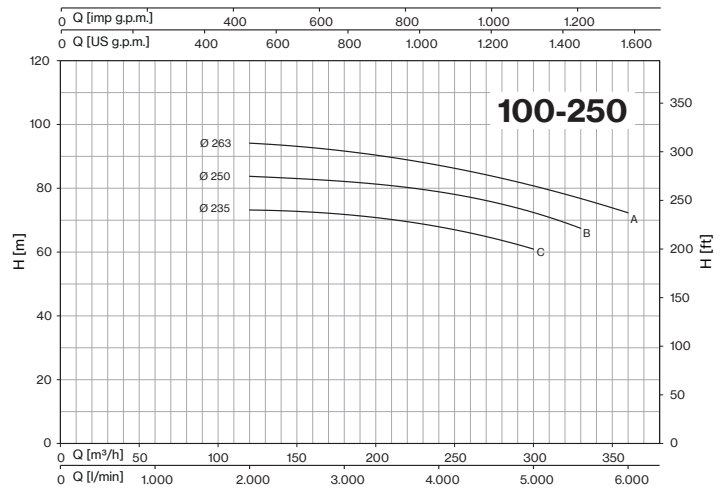
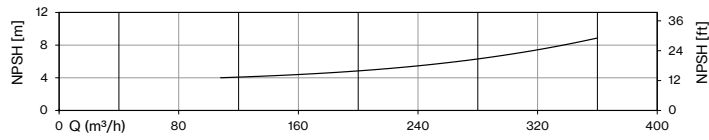
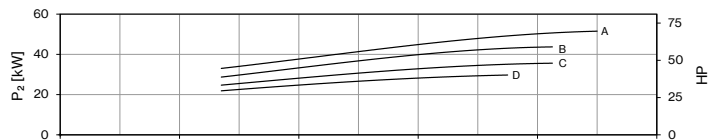
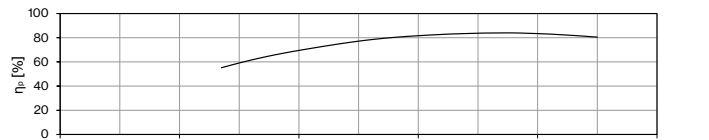
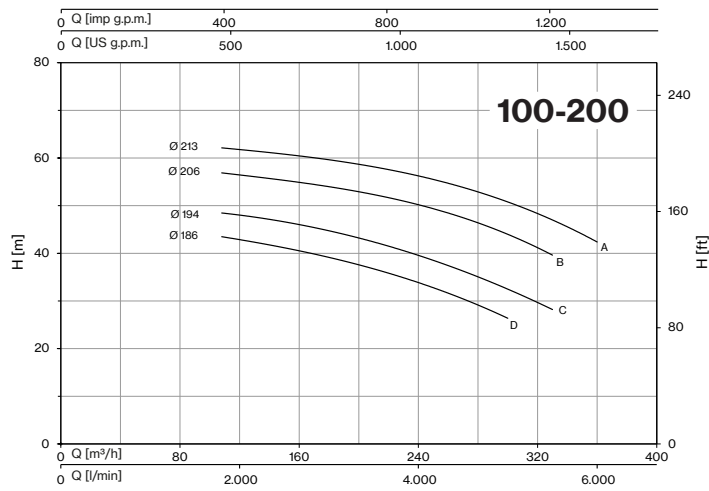
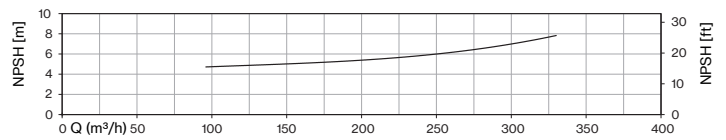
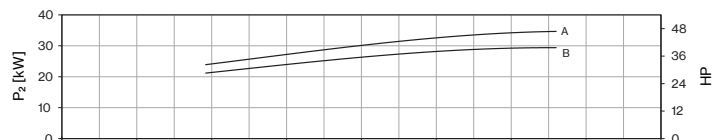
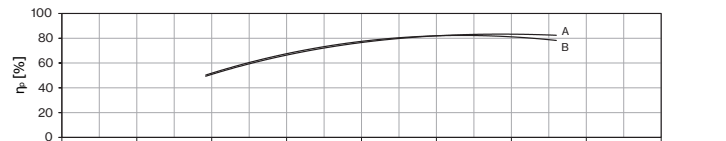
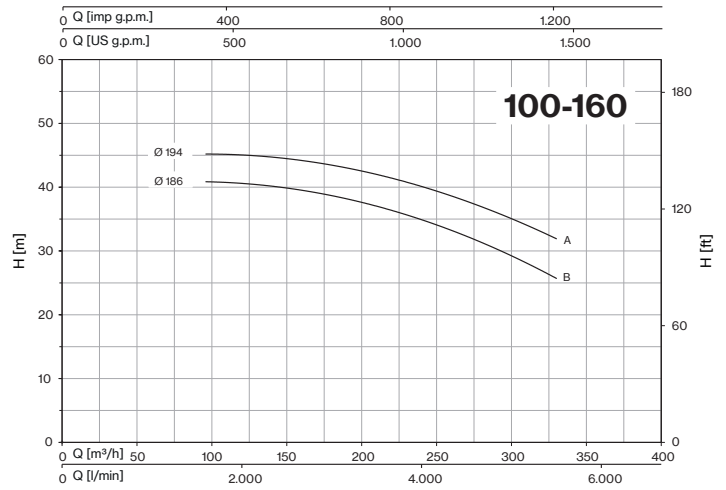
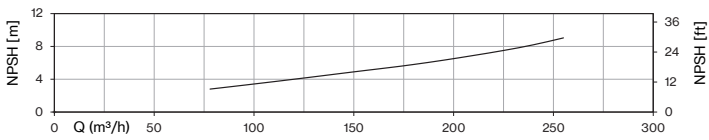
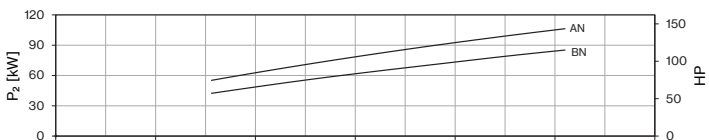
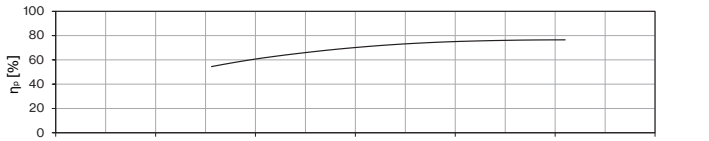
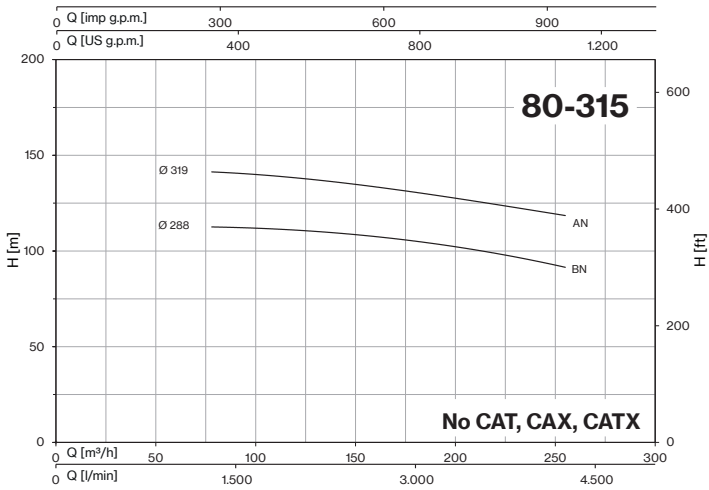

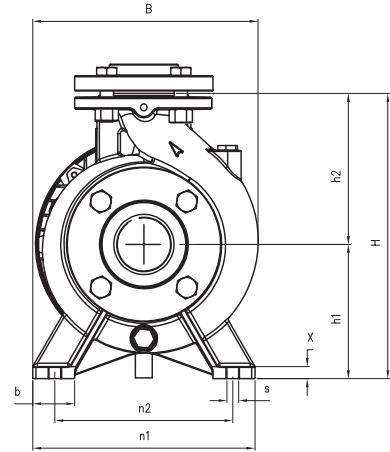
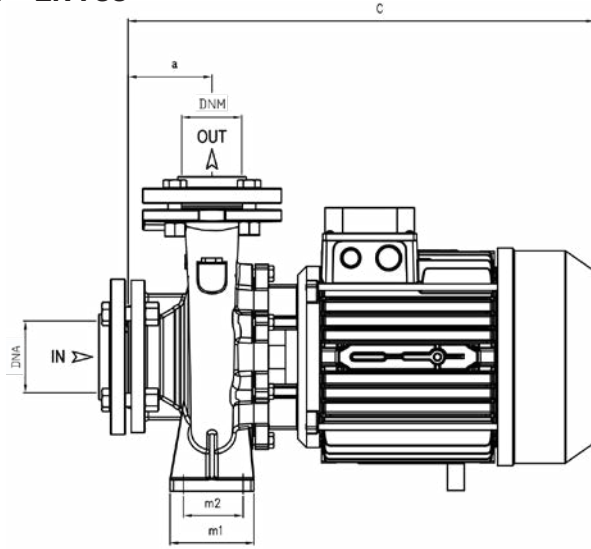

**CM ~ EN 733**



MEC	3~ TYPE	1~ TYPE	DIMENSIONS (mm)																		 Kg		
			DNA	DNM	a	h1	h2	m1	m2	n1	n2	b	x	s	C	B	H	I	L			M	
90	<b>32-160 C</b>	<b>32-160 C</b>	50	32	80	132	160	100	70	240	190	50	12	14	530	240	292	551	250	341	41		
90	<b>32-160 B</b>	<b>32-160 B</b>			80	132	160	100	70	240	190	50	12	14	530	240	292	551	250	341	44		
90	<b>32-160 A</b>				80	132	160	100	70	240	190	50	12	14	530	240	292	551	250	341	47		
112		<b>32-200 C</b>			80	160	180	100	70	240	190	50	12	14	574	268	340	602	263	395	65,5		
100	<b>32-200 C</b>				80	160	180	100	70	240	190	50	12	14	540	268	340	602	263	395	56,5		
112	<b>32-200 B1</b>				80	160	180	100	70	240	190	50	12	14	520	268	340	627	287	408	65,5		
132	<b>32-200 B</b>				80	160	180	100	70	240	190	50	12	14	565	268	340	627	287	408	72		
112	<b>32-200 A1</b>				80	160	180	100	70	240	190	50	12	14	520	268	340	627	287	408	72		
132	<b>32-200 A</b>				80	160	180	100	70	240	190	50	12	14	565	268	340	627	287	408	79		
132	<b>32-250 C</b>				100	180	225	125	95	320	250	65	12	14	625	305	405	666	346	471	101,5		
132	<b>32-250 B</b>				100	180	225	125	95	320	250	65	14	14	625	305	405	666	346	471	105,5		
132	<b>32-250 A1</b>				100	180	225	125	95	320	250	65	14	14	670	305	405	810	354	480	110		
160	<b>32-250 A</b>				100	180	225	125	95	320	250	65	14	14	695	305	405	810	354	480	135,5		
90	<b>40-125 C</b>	<b>40-125 C</b>			65	40	80	112	140	100	70	210	160	50	12	14	535	220	252	551	250	341	41,5
90	<b>40-125 B</b>	<b>40-125 B</b>					80	112	140	100	70	210	160	50	12	14	535	220	252	551	250	341	44
90	<b>40-125 A</b>						80	112	140	100	70	210	160	50	12	14	535	220	252	551	250	341	47,5
100		<b>40-160 B</b>	80	132			160	100	70	240	190	50	12	14	535	245	292	551	250	341	56		
100	<b>40-160 B</b>		80	132			160	100	70	240	190	50	12	14	535	245	292	551	250	341	52		
112		<b>40-160 A</b>	80	132			160	100	70	240	190	50	15	14	579	245	292	602	263	395	64,5		
100	<b>40-160 A</b>		80	132			160	100	70	240	190	50	15	14	535	245	292	602	263	395	56,5		
112	<b>40-160 AP</b>		80	132			160	100	70	240	190	50	15	14	579	245	292	627	287	408	63		
112	<b>40-200 B1</b>		100	160			180	100	70	265	212	50	15	14	597	273	340	627	287	408	68		
132	<b>40-200 B</b>		100	160			180	100	70	265	212	50	15	14	590	273	340	627	287	408	74,5		
112	<b>40-200 A1</b>		100	160			180	100	70	265	212	50	15	14	597	273	340	627	287	408	74		
132	<b>40-200 A</b>		100	160			180	100	70	265	212	50	15	14	590	273	340	627	287	408	81		
132	<b>40-200 AP</b>		100	160			180	100	70	265	212	50	15	14	628	273	340	666	346	471	93,5		
132	<b>40-250 C</b>		100	180			225	125	95	320	250	65	15	14	630	322	405	666	346	471	100,5		
132	<b>40-250 B</b>		100	180			225	125	95	320	250	65	15	14	630	322	405	666	346	471	105		
132	<b>40-250 A1</b>		100	180			225	125	95	320	250	65	15	14	675	322	405	810	354	480	109,5		
160	<b>40-250 A</b>		100	180	225	125	95	320	250	65	15	14	700	322	405	810	354	480	135				
132	<b>40-250 BM</b>		100	180	225	125	95	320	250	65	15	14	750	332	405	810	354	480	150				
160	<b>40-250 AM</b>		100	180	225	125	95	320	250	65	15	14	750	332	405	810	354	480	160,5				
100		<b>50-125 B</b>	65	50	100	132	160	100	70	240	190	50	12	14	525	250	292	602	263	395	57,5		
100	<b>50-125 B</b>				100	132	160	100	70	240	190	50	12	14	560	250	292	602	263	395	53,5		
112		<b>50-125 A</b>			100	132	160	100	70	240	190	50	12	14	610	250	292	602	263	395	65,5		
100	<b>50-125 A</b>				100	132	160	100	70	240	190	50	12	14	560	250	292	602	263	395	57,5		
112	<b>50-160 B1</b>				100	160	180	100	70	265	212	50	12	14	597	270	340	627	287	408	68,5		
132	<b>50-160 B</b>				100	160	180	100	70	265	212	50	12	14	590	270	340	627	287	408	74,5		
112	<b>50-160 A1</b>				100	160	180	100	70	265	212	50	12	14	597	270	340	627	287	408	74,5		
132	<b>50-160 A</b>				100	160	180	100	70	265	212	50	12	14	590	270	340	627	287	408	81		
132	<b>50-200 C</b>				100	160	200	100	70	265	215	50	12	14	635	290	360	666	346	471	98		
132	<b>50-200 B</b>				100	160	200	100	70	265	215	50	12	14	635	290	360	666	346	471	102,5		
132	<b>50-200 A1</b>				100	160	200	100	70	265	215	50	12	14	680	290	360	810	354	480	107		
160	<b>50-200 A</b>				100	160	200	100	70	265	215	50	12	14	705	290	360	810	354	480	132,5		



MEC	3- TYPE	1- TYPE	DIMENSIONS (mm)																		 Kg		
			DNA	DNM	a	h1	h2	m1	m2	n1	n2	b	x	s	C	B	H	I	L			M	
132	50-250 C1		65	50	100	180	225	125	95	320	250	65	14	14	680	332	405	810	354	480	113,5		
160	50-250 C				100	180	225	125	95	320	250	65	14	14	705	332	405	810	354	480	139		
160	50-250 B				100	180	225	125	95	320	250	65	14	14	750	332	405	810	354	480	154		
160	50-250 A				100	180	225	125	95	320	250	65	14	14	750	332	405	810	354	480	164		
112	65-125 B1		80	65	100	160	180	125	95	280	212	65	14	14	612	280	340	627	287	408	70		
132	65-125 B				100	160	180	125	95	280	212	65	14	14	605	280	340	627	287	408	76,5		
112	65-125 A1				100	160	180	125	95	280	212	65	14	14	612	280	340	627	287	408	76,5		
132	65-125 A				100	160	180	125	95	280	212	65	14	14	605	280	340	627	287	408	83		
132	65-160 C				100	160	200	125	95	280	212	65	14	14	635	290	360	666	346	471	99,5		
132	65-160 B				100	160	200	125	95	280	212	65	14	14	635	290	360	666	346	471	103,5		
132	65-160 A1				100	160	200	125	95	280	212	65	14	14	680	290	360	810	354	480	107,5		
160	65-160 A				100	160	200	125	95	280	212	65	14	14	705	290	360	810	354	480	135		
132	65-200 C1				100	180	225	125	95	320	250	65	14	14	680	330	405	810	354	480	113		
160	65-200 C				100	180	225	125	95	320	250	65	14	14	705	330	405	810	354	480	138,5		
160	65-200 B				100	180	225	125	95	320	250	65	14	14	750	330	405	810	354	480	153		
160	65-200 A				100	180	225	125	95	320	250	65	14	14	750	330	405	810	354	480	163,5		
180	65-250 B				100	200	250	160	120	360	280	80	16	19	820	370	450	920	420	625	203,5		
180	65-250 A				100	200	250	160	120	360	280	80	16	19	860	370	450	920	420	625	226		
132	80-160 E				100	80	125	180	225	125	95	320	250	65	14	14	665	330	405	810	354	480	110
132	80-160 D						125	180	225	125	95	320	250	65	14	14	665	330	405	810	354	480	114
132	80-160 C1		125	180			225	125	95	320	250	65	14	14	710	330	405	810	354	480	118		
160	80-160 C		125	180			225	125	95	320	250	65	14	14	735	330	405	810	354	480	143		
160	80-160 B		125	180			225	125	95	320	250	65	14	14	780	330	405	810	354	480	157,5		
160	80-160 A		125	180			225	125	95	320	250	65	14	14	780	330	405	810	354	480	168		
180	80-200 B		125	180			250	125	95	345	280	65	16	14	840	355	430	920	420	625	200		
180	80-200 A		125	180			250	125	95	345	280	65	16	14	880	355	430	920	420	625	222		
180	100-160 B		125	100	125	200	280	160	120	360	280	80	18	18	842	390	480	920	420	625	208		
180	100-160 A				125	200	280	160	120	360	280	80	18	18	882	390	480	920	420	625	230,5		

DIMENSIONS (mm)				
DN	D	K	holes	
			n°	Ø
32	140	100	4	18
40	150	110	4	18
50	165	125	4	18
65	185	145	4	18
80	200	160	8	18
100	220	180	8	18
125	250	210	8	18

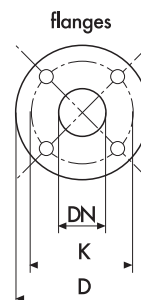



TYPE	LOTS			
	TRUCK		CONTAINER	
	PALLET (cm)	N° pumps	PALLET (cm)	N° pumps
32-160	80×120×155	24	80×120×190	30
32-200 (C)	80×120×155	24	80×120×180	24
32-200 (A) (A1) (B) (B1)	100×120×140	18	100×120×185	24
32-250 (A)	85×110×120	6	85×110×170	9
32-250 (B) (C)	80×120×120	6	80×120×170	9
40-125	80×120×155	24	80×120×190	30
40-160	80×120×155	24	80×120×190	30
40-200	100×120×140	18	100×120×185	24
40-250 (A)	85×110×120	6	85×110×170	9
40-250 (B) (BM) (C)	80×120×120	6	80×120×170	9
50-125	80×120×120	24	80×120×180	24
50-160	100×120×140	18	100×120×185	24
50-200 (A)	85×110×120	6	85×110×170	9
50-200 (B) (C)	80×120×120	6	80×120×170	9
50-250	80×120×120	6	80×120×170	9
65-125	100×120×140	18	100×120×185	24
65-160	85×110×120	6	85×110×170	9
65-200	85×110×120	6	85×110×170	9
65-250	85×110×130	4	85×110×190	6
80-160	85×110×120	6	85×110×170	9
80-200	85×110×130	4	85×110×190	6
100-160	85×110×130	4	85×110×190	6





# CM Serie-Mechanical seal and bearings

MECHANICAL SEAL	PUMP MODEL	SHAFT Ø		STANDARD MATERIAL	OPTIONAL			
					E	V	2E	2V
	32-160, 40-125	20mm	<b>Rotating face</b> <b>Stationary face</b> <b>Elastomer</b>	Ceramic Graphite NBR	Ceramic Graphite EPDM	- - -	SiC SiC EPDM	SiC SiC FKM
	40-250M	28mm	<b>Rotating face</b> <b>Stationary face</b> <b>Elastomer</b>	Ceramic Graphite EPDM	- - -	- - -	SiC SiC EPDM	SiC SiC FKM
	32-200, 32-250, 40-160, 40-160P, 40-200, 40-200P, 40-250, 50-125, 50-160, 50-200, 50-250, 65-125, 65-160, 65-200, 80-160	28mm	<b>Rotating face</b> <b>Stationary face</b> <b>Elastomer</b>	Ceramic Graphite NBR	Ceramic Graphite EPDM	Ceramic Graphite FKM	SiC SiC EPDM	SiC SiC FKM
	65-250, 80-200, 100-160	40mm	<b>Rotating face</b> <b>Stationary face</b> <b>Elastomer</b>	CrNi-steel Graphite NBR	CrNi-steel Graphite EPDM	CrNi-steel Graphite FKM	SiC SiC EPDM	SiC SiC FKM

BEARINGS	PUMP MODEL	TYPE	
	32-200C, 40-160B, 40-160A, 50-125B, 50-125A	6204-ZZ	6206-ZZ C3
	32-160C, 32-160B, 32-160A, 40-125C, 40-125B, 40-125A	6205-ZZ C3	6203-ZZ
	1- 32-200C, 32-200B1, 32-200B, 32-200A1, 32-200A, 32-250C, 32-250B, 1- 40-160A, 40-160AP, 40-200B1, 40-200B, 40-200A1, 40-200A, 40-200AP, 40-250C, 40-250B, 1- 50-125A, 50-160B1, 50-160B, 50-160A1, 50-160A, 50-200C, 50-200B, 65-125B1, 65-125B, 65-125A1, 65-125A, 65-160C, 65-160B, 80-160E, 80-160D	6206-ZZ C3	6306-ZZ C3
	32-250A1, 40-250A1, 50-200A1, 50-200C1, 65-160A1, 65-200C1, 80-160C1	6308-ZZ C3	6306-ZZ C3
	32-250A, 40-250A, 40-250BM, 40-250AM, 50-200A, 50-250C, 50-250B, 50-250A, 65-160A, 65-200C, 65-200B, 65-200A, 80-160C, 80-160B, 80-160A	6308-ZZ C3	6309-ZZ C3
	65-250B, 65-250A, 80-200B, 80-200A, 100-160B, 100-160A	6309-ZZ C3	6310-ZZ C3

